



# XB meccanismo per antine ribaltabili

## Lowering mechanism for cabinet door • Systèmes pour porte abattant

# XB

Art.	POTENZA CAPACITY Force		
<b>XB 060</b>	60 N	50	7
<b>XB 080</b>	80 N	50	7
<b>XB 100</b>	100 N	50	7

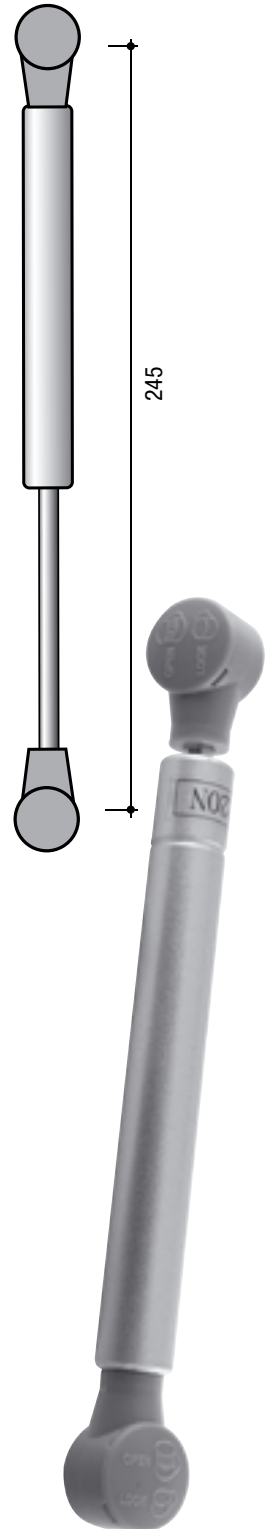

**Attacco per fianco**  
Attachment for side panel  
Attaque cadres

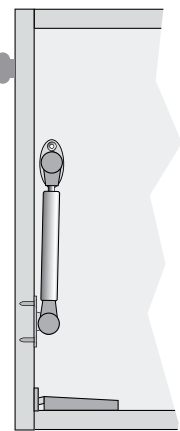
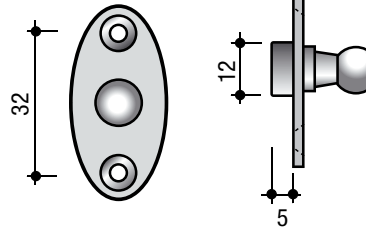

**Attacco per ante in legno**  
Attachment for wooden frames  
Attaque cadres bois

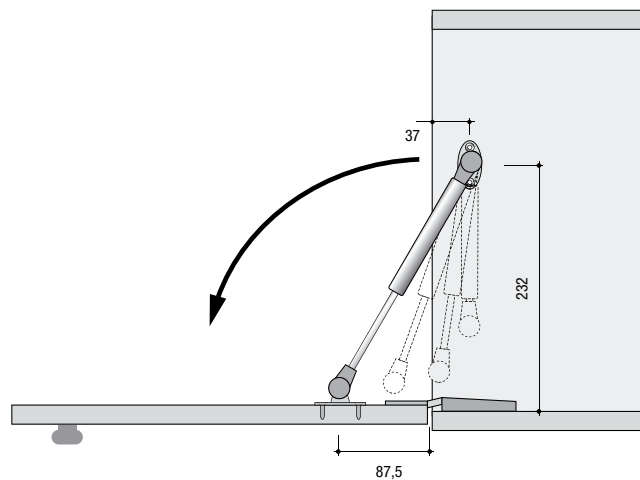
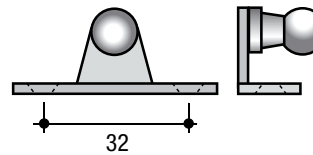

Art.	L
<b>XA 05</b>	M6 x 8
<b>XA 06</b>	M6 x 14

**Attacco per fianco**  
Attachment for side panel  
Attaque cadres

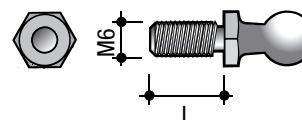

Art.
<b>XA 04</b>

**Attacco per ante in alluminio**  
Attachment for aluminium frames  
Attaque cadres Aluminium

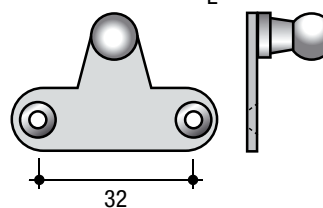

Art.
<b>XA 07</b>

**Attacco per fianco**  
Attachment for side panel  
Attaque cadres

