

Catalogue 2023

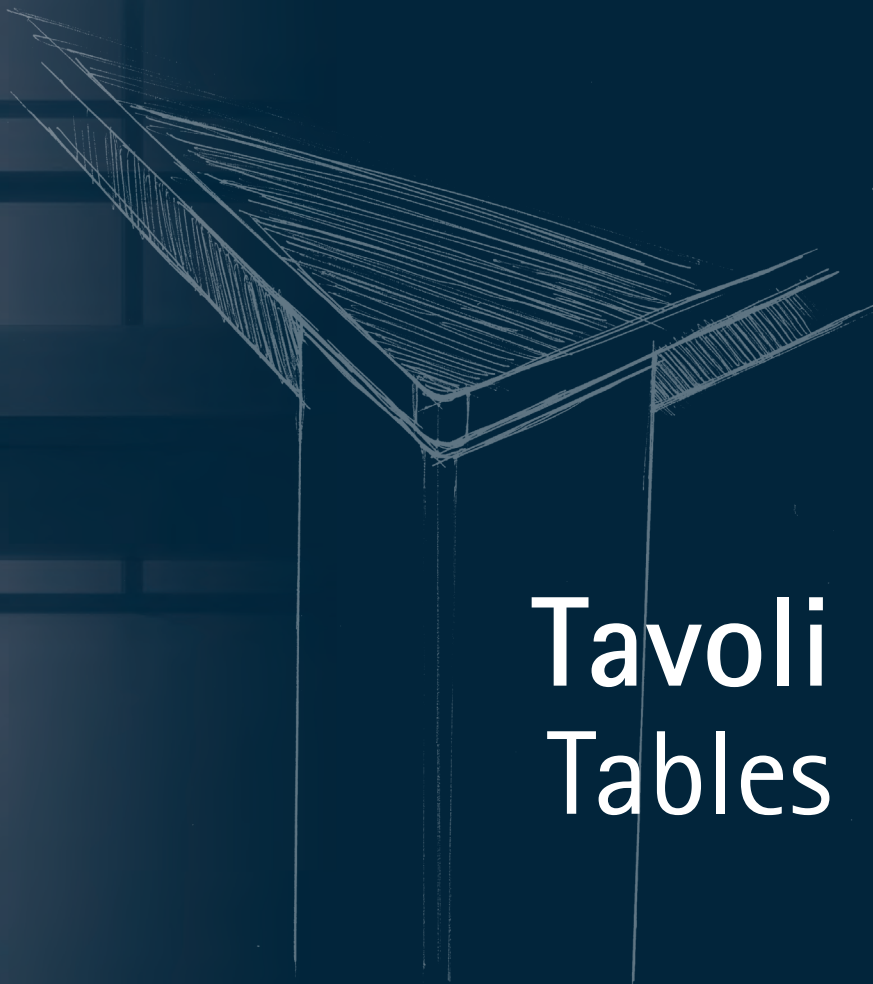

Tavoli Tables

IN
OUT
STRUTTURA

Strutture tavoli

Tables structures

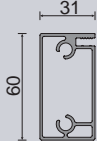
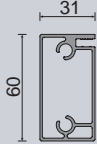
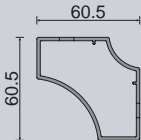
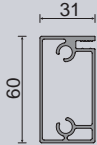
SERIE series	GAMBE legs	TRAVERSI traverses	PAG. page
B1			318
B2			322
B4			326
B5			330
B6			334
B3			338

Informazioni tecniche

Technical information

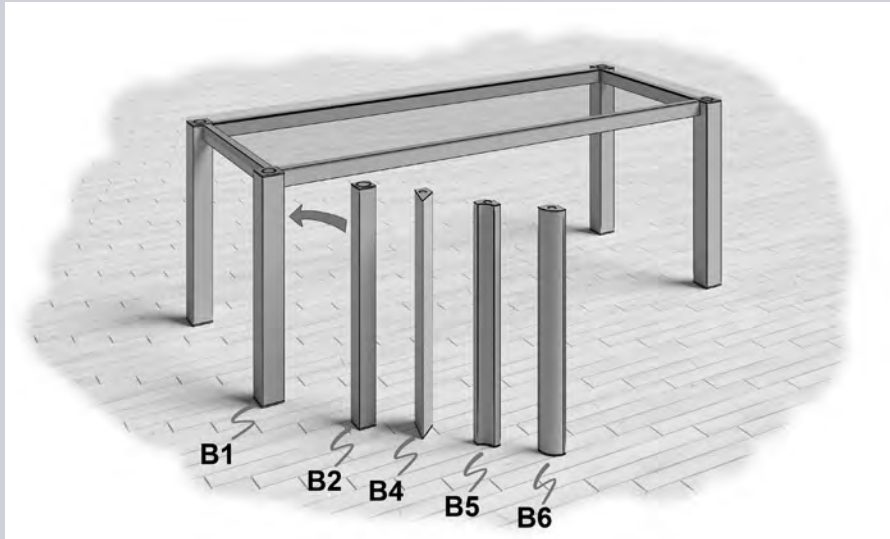

Il nuovo sistema di strutture per tavoli IN-OUT è caratterizzato da 3 aspetti fondamentali:

Semplicità

Montaggio estremamente rapido e intuitivo.

Intercambiabilità

Possibilità di utilizzare diversi modelli di gamba sullo stesso telaio.

Flessibilità

Capacità di adattarsi a situazioni e spazi diversi.

Realizzate interamente in alluminio, le strutture IN-OUT possono essere impiegate in svariati ambienti, dalla casa all'ufficio e all'outdoor.

Grazie alla varietà di gambe permettono di soddisfare i gusti più classici ma anche chi è alla ricerca di un design innovativo ed alla moda.

Estremamente facili e intuitive nelle operazioni di montaggio affiancano a questa caratteristica la possibilità di essere inserite anche in spazi esterni e un'elevata praticità grazie a un peso estremamente contenuto e un'elevata resistenza.

Tutti i sistemi IN-OUT sono coperti da tutela brevettuale.

The new system of structures for IN-OUT tables is characterized by 3 fundamental features:

Simplicity

Extremely quick and intuitive assembly.

Interchangeability

Possibility of using different leg models on the same frame.

Ductility

Adaptability to different situations and spaces.

Made entirely of aluminum, the IN-OUT structures can be used in various environments, from home to office up to outdoor.

Thanks to the variety of legs, they can satisfy the most classic tastes as well as those looking for an innovative and fashionable design.

These structures combine the easy and intuitive assembly with high manageability, thanks to the extremely low weight, and high resistance (they can also be used outdoors).

All IN-OUT systems are covered by patent protection.

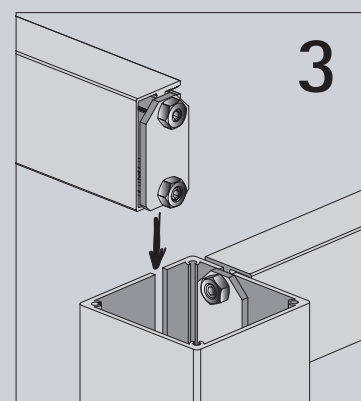
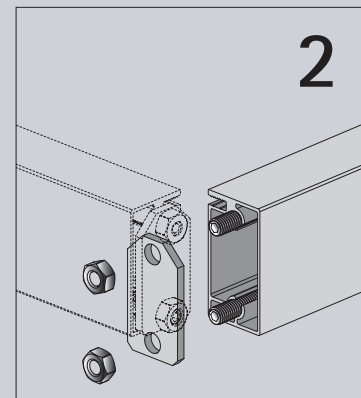
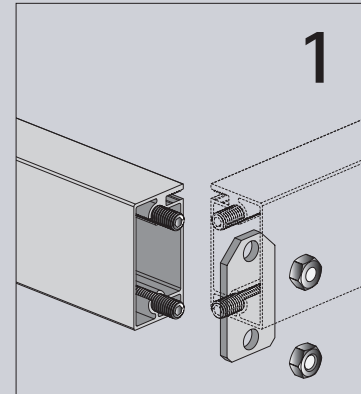





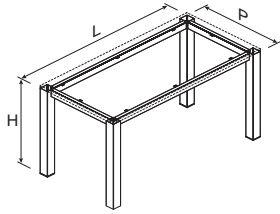

B1 Strutture tavolo Table structures

**PATENT
PENDING**





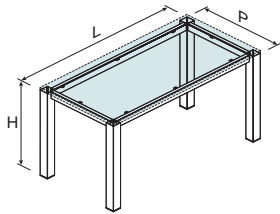

Top in nobilitato
Chipboard top

Code	 mm	 pcs	 kg	 min
80B1K001F	1290 x 790 x 750	1	15	5
80B1K002F	1590 x 790 x 750	1	16	5
80B1K003F	1990 x 990 x 750	1	17	5





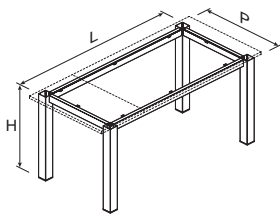

Top in vetro
Glass top

Code	 mm	 pcs	 kg	 min
80B1K001C	1290 x 790 x 750	1	15	5
80B1K002C	1590 x 790 x 750	1	16	5
80B1K003C	1990 x 990 x 750	1	17	5



Top allungabile
Extendible top

Code	 mm	 pcs	 kg	 min
80B1K001A	1290 x 790 x 750	1	15	5
80B1K002A	1590 x 790 x 750	1	16	5
80B1K003A	1990 x 990 x 750	1	17	5





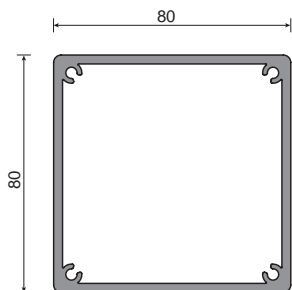

for
za

Le confezioni contengono la struttura smontata, ferramenta e istruzioni di montaggio
Packages contain the disassembled structure, hardware and assembly instructions

B1 Kit profili Profiles kit





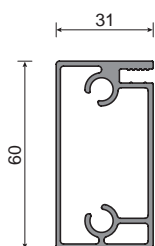

Profilo gamba
Leg profile

Code	 mm	 m	 kg	 min
80B1G00	3850	15,4	40	77



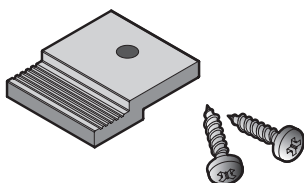

Profilo trasverso
Spar profile

Code	 mm	 m	 kg	 min
80B4F00	4620	18,48	21	92,5



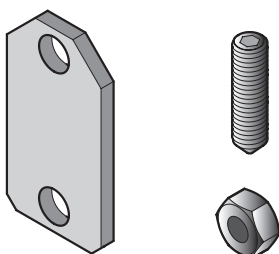

Confezione accessori per piano
in nobilitato
Accessories set for chipboard top

Code	 pcs	 kg	 min
81B1C002	50	6	50





Confezione accessori per
struttura tavolo
Accessories for table structure

Code	 pcs	 kg	 min
81B4H001	25	7	50

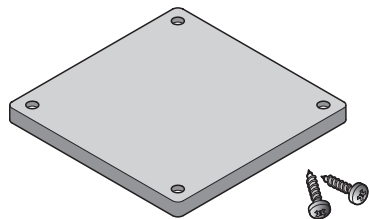
B1 Kit profili Profiles kit





Tappo inferiore
Lower cover cup

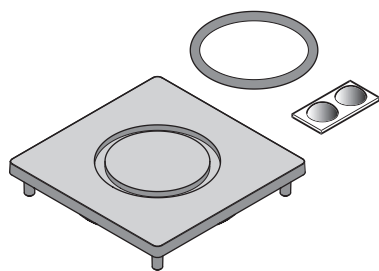



Code	 pcs	 kg	 min
81B1K000	50	7	50

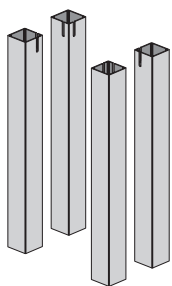

Tappo superiore
Upper cover cup

Code	 pcs	 kg	 min
81B1L000	50	6	50



	Code	 mm	 pcs	 kg	 min
fisso fixed	81B1AF750XX	750	4	5	20
allungabile extensible	81B1AA750XX	750	4	5	20
cristallo glass	81B1AC750XX	750	4	8	20

KIT 4

Gambe c/asola per tavolo fisso/allungabile e cristallo
Set 4 legs with slot for fixed/extensible and glass table





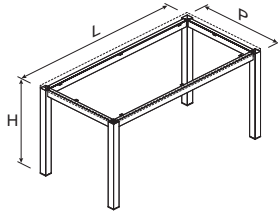

B2 Strutture tavolo Table structures

**PATENT
PENDING**





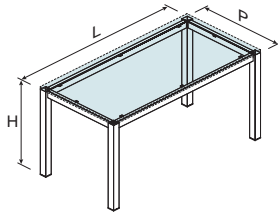

Top in nobilitato
Chipboard top

Code	 mm	 pcs	 kg	 min
80B2K001F	1290 x 790 x 750	1	10	5
80B2K002F	1590 x 790 x 750	1	11	5
80B2K003F	1990 x 990 x 750	1	12	5





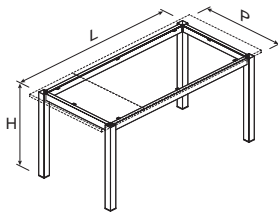

Top in vetro
Glass top

Code	 mm	 pcs	 kg	 min
80B2K001C	1290 x 790 x 750	1	10	5
80B2K002C	1590 x 790 x 750	1	11	5
80B2K003C	1990 x 990 x 750	1	12	5



Top allungabile
Extendible top

Code	 mm	 pcs	 kg	 min
80B2K001A	1290 x 790 x 750	1	10	5
80B2K002A	1590 x 790 x 750	1	11	5
80B2K003A	1990 x 990 x 750	1	12	5





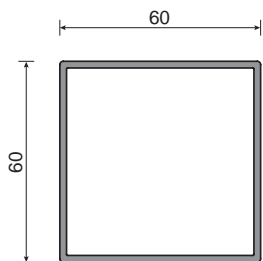

Le confezioni contengono la struttura smontata, ferramenta e istruzioni di montaggio
Packages contain the disassembled structure, hardware and assembly instructions

B2 Kit profili Profiles kit



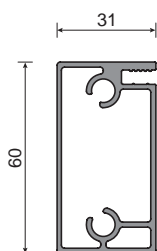

Profilo gamba
Leg profile

Code	 mm	 m	 kg	 min
80B2G00	3850	15,4	20	77



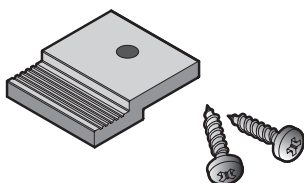

Profilo trasverso
Spar profile

Code	 mm	 m	 kg	 min
80B4F00	4620	18,48	21	92,5



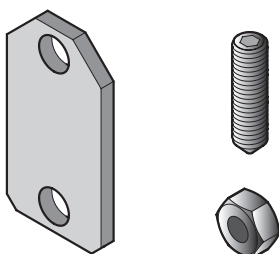

Confezione accessori per piano
in nobilitato
Accessories set for chipboard top

Code	 pcs	 kg	 min
81B1C002	50	6	50





Confezione accessori per
struttura tavolo
Accessories for table structure

Code	 pcs	 kg	 min
81B4H001	25	7	50

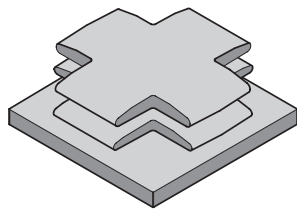
B2 Kit profili Profiles kit





Tappo inferiore
Lower cover cup

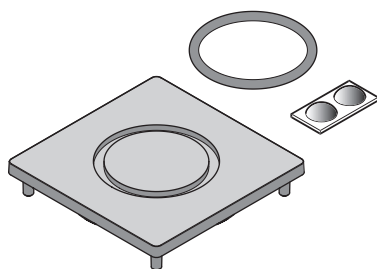



Code	 pcs	 kg	 min
81B2K000	50	8	50

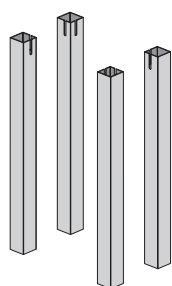

Tappo superiore
Upper cover cup

Code	 pcs	 kg	 min
81B2L000	50	6	50



	Code	 mm	 pcs	 kg	 min
fisso fixed	80B2AF750XX	750	4	5	20
allungabile extensible	80B2AA750XX	750	4	5	20
cristallo glass	80B2AC750XX	750	4	20	20

KIT 4

Gambe c/asola per tavolo fisso/allungabile e cristallo
Set 4 legs with slot for fixed/extensible and glass table



B4 Strutture tavolo Table structures

**PATENT
PENDING**

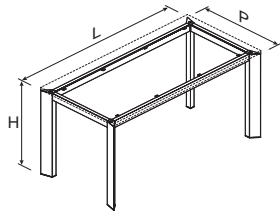

Top in nobilitato
Chipboard top



Code	mm	pcs	kg	min
80B4K001F	1290 x 790 x 750	1	10	5
80B4K002F	1590 x 790 x 750	1	11	5
80B4K003F	1990 x 990 x 750	1	12	5

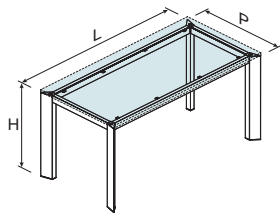

Top in vetro
Glass top



Code	mm	pcs	kg	min
80B4K001C	1290 x 790 x 750	1	10	5
80B4K002C	1590 x 790 x 750	1	11	5
80B4K003C	1990 x 990 x 750	1	12	5

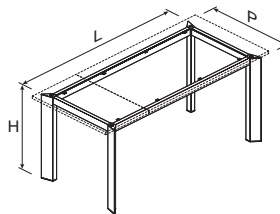

Top allungabile
Extensible top



Code	mm	pcs	kg	min
80B4K001A	1290 x 790 x 750	1	10	5
80B4K002A	1590 x 790 x 750	1	11	5
80B4K003A	1990 x 990 x 750	1	12	5





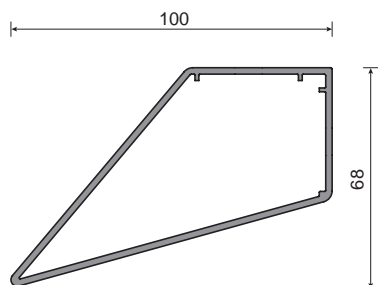

e
gan
za

Le confezioni contengono la struttura smontata, ferramenta e istruzioni di montaggio
Packages contain the disassembled structure, hardware and assembly instructions

B4 Kit profili Profiles kit





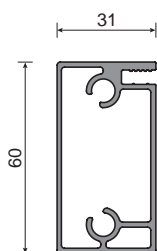

Profilo gamba
Leg profile

Code	 mm	 m	 kg	 min
80B4G00	3850	15,4	25	77



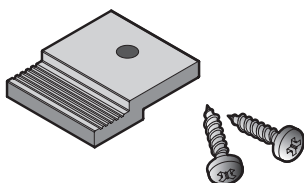

Profilo trasverso
Spar profile

Code	 mm	 m	 kg	 min
80B4F00	4620	18,48	21	92,5



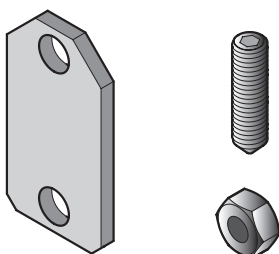

Confezione accessori per piano
in nobilitato
Accessories set for chipboard top

Code	 pcs	 kg	 min
81B1C002	50	6	50



Confezione accessori per
struttura tavolo
Accessories for table structure

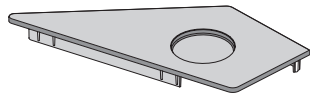

Code	 pcs	 kg	 min
81B4H001	25	7	50

B4 Kit profili Profiles kit



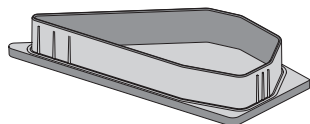

Tappo inferiore e superiore
Upper and lower cover cup



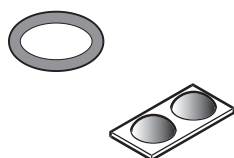



Code	 pcs	 kg	 min
81B4K000	50	10	50

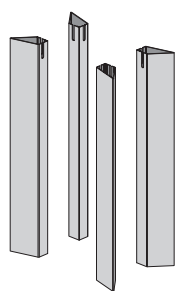

Accessori per piano in
cristallo
Accessories for glass top

Code	 pcs	 kg	 min
81B4L000	50	5	50



	Code	 mm	 pcs	 kg	 min
fisso fixed	80B4AF750XX	750	4	5	20
allungabile extensible	80B4AA750XX	750	4	5	20
cristallo glass	80B4AC750XX	750	4	5	20

KIT 4

Gambe per tavolo fisso/allungabile e cristallo
Set 4 legs for fixed/extensible and glass table





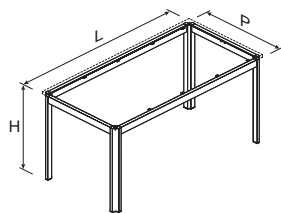

B5 Strutture tavolo Table structures

**PATENT
PENDING**





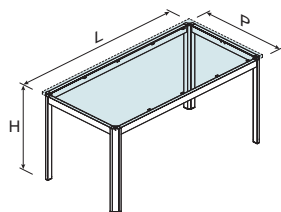

Top in nobilitato
Chipboard top

Code	 mm	 pcs	 kg	 min
80B5K001F	1290 x 790 x 750	1	10	5
80B5K002F	1590 x 790 x 750	1	11	5
80B5K003F	1990 x 990 x 750	1	12	5





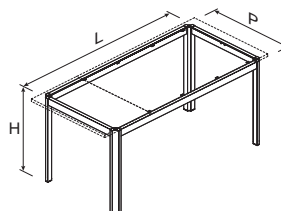

Top in vetro
Glass top

Code	 mm	 pcs	 kg	 min
80B5K001C	1290 x 790 x 750	1	10	5
80B5K002C	1590 x 790 x 750	1	11	5
80B5K003C	1990 x 990 x 750	1	12	5



Top allungabile
Extensible top

Code	 mm	 pcs	 kg	 min
80B5K001A	1290 x 790 x 750	1	10	5
80B5K002A	1590 x 790 x 750	1	11	5
80B5K003A	1990 x 990 x 750	1	12	5





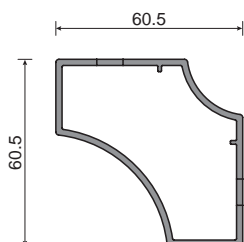

Le confezioni contengono la struttura smontata, ferramenta e istruzioni di montaggio
Packages contain the disassembled structure, hardware and assembly instructions

B5 Kit profili Profiles kit





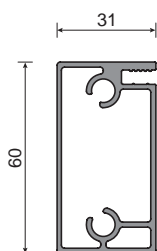

Profilo gamba
Leg profile

Code	 mm	 m	 kg	 min
80B5G00	3850	15,4	7	77



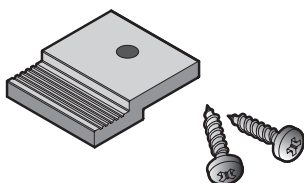

Profilo trasverso
Spar profile

Code	 mm	 m	 kg	 min
80B4F00	4620	18,48	21	92,5



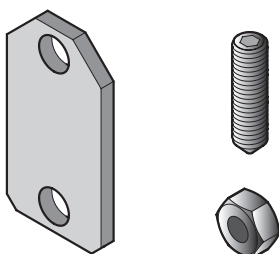

Confezione accessori per piano
in nobilitato
Accessories set for chipboard top

Code	 pcs	 kg	 min
81B1C002	50	6	50





Confezione accessori per
struttura tavolo
Accessories for table structure

Code	 pcs	 kg	 min
81B4H001	25	7	50

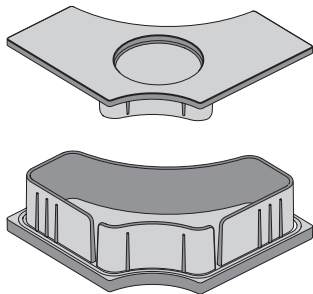
B5 Kit profili Profiles kit





Tappo inferiore e superiore
Upper and lower cover cup

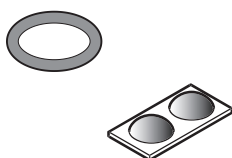



Code	 pcs	 kg	 min
81B5K000	50	10	50

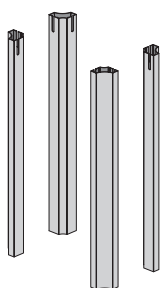

Accessori per piano in
cristallo
Accessories for glass top

Code	 pcs	 kg	 min
81B4L000	50	5	50



	Code	 mm	 pcs	 kg	 min
fisso fixed	80B5AF750XX	750	4	5	20
allungabile extensible	80B5AA750XX	750	4	5	20
cristallo glass	80B5AC750XX	750	4	5	20

KIT 4

Gambe per tavolo fisso/allungabile e cristallo
Set 4 legs for fixed/extensible and glass table



B6 Strutture tavolo Table structures

**PATENT
PENDING**

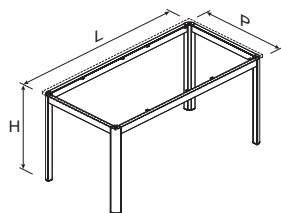

Top in nobilitato
Chipboard top



Code	mm	pcs	kg	min
80B6K001F	1290 x 790 x 750	1	10	5
80B6K002F	1590 x 790 x 750	1	11	5
80B6K003F	1990 x 990 x 750	1	12	5

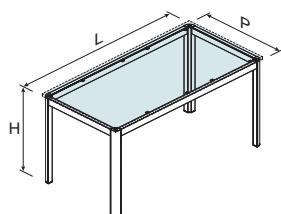

Top in vetro
Glass top



Code	mm	pcs	kg	min
80B6K001C	1290 x 790 x 750	1	10	5
80B6K002C	1590 x 790 x 750	1	11	5
80B6K003C	1990 x 990 x 750	1	12	5

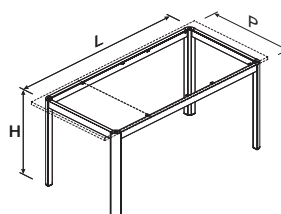

Top allungabile
Extendible top



Code	mm	pcs	kg	min
80B6K001A	1290 x 790 x 750	1	10	5
80B6K002A	1590 x 790 x 750	1	11	5
80B6K003A	1990 x 990 x 750	1	12	5





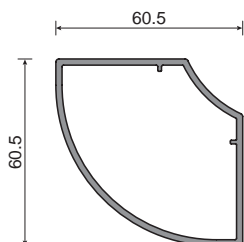

Le confezioni contengono la struttura smontata, ferramenta e istruzioni di montaggio
Packages contain the disassembled structure, hardware and assembly instructions

B6 Kit profili Profiles kit





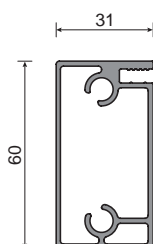

Profilo gamba
Leg profile

Code	 mm	 m	 kg	 min
80B6G00	3850	15,4	7	77



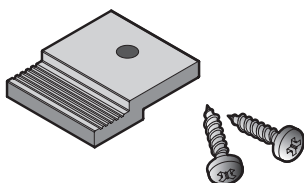

Profilo traverso
Spar profile

Code	 mm	 m	 kg	 min
80B4F00	4620	18,48	21	92,5



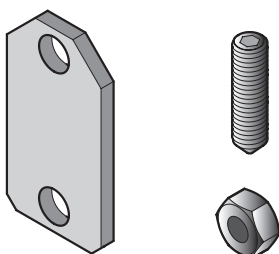

Confezione accessori per piano
in nobilitato
Accessories set for chipboard top

Code	 pcs	 kg	 min
81B1C002	50	6	50





Confezione accessori per
struttura tavolo
Accessories for table structure

Code	 pcs	 kg	 min
81B4H001	25	7	50

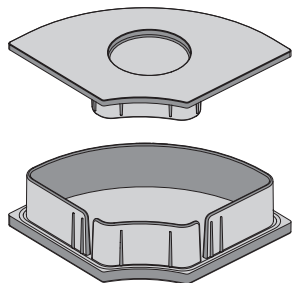
B6 Kit profili Profiles kit





Tappo inferiore e superiore
Upper and lower cover cup

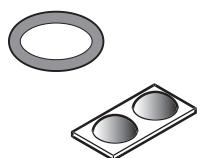



Code	 pcs	 kg	 min
81B6K000	50	10	50

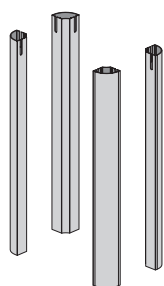

Accessori per piano in
cristallo
Accessories for glass top

Code	 pcs	 kg	 min
81B4L000	50	5	50



	Code	 mm	 pcs	 kg	 min
fisso fixed	80B6AF750XX	750	4	5	20
allungabile extensible	80B6AA750XX	750	4	5	20
cristallo glass	80B6AC750XX	750	4	5	20

KIT 4

Gambe per tavolo fisso/allungabile e cristallo
Set 4 legs for fixed/extensible and glass table





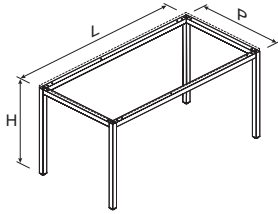

B3 Strutture tavolo Table structures

**PATENT
PENDING**



Top in nobilitato
Chipboard top

Code	 mm	 pcs	 kg	 min
80B3K001	1290 x 790 x 750	1	7	5
80B3K002	1590 x 790 x 750	1	8	5





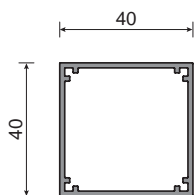

Le confezioni contengono la struttura smontata, ferramenta e istruzioni di montaggio
Packages contain the disassembled structure, hardware and assembly instructions

B3 Kit profili Profiles kit



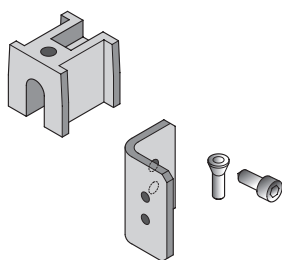

Profilo gamba
Leg profile

Code	 mm	 m	 kg	 min
80B3F00	5200	20,8	15	104



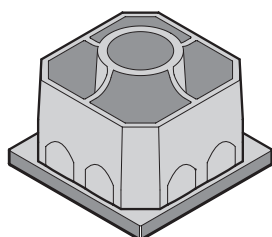

Sistema giunzione
Joint system

Code	 pcs	 kg	 min
81B3H000	50	8	50



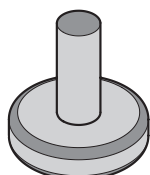

Tappo inferiore filettato M10
Lower cover cup M10

Code	 pcs	 kg	 min
81B3K000	50	5	50





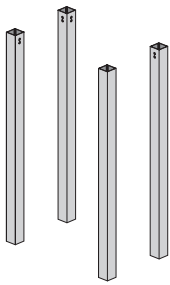

KIT 14
Piedini regolabili
Adjustable legs

Code	 pcs	 kg	 min
81B3K001	50	5	50

B3 Kit profili Profiles kit



KIT 4
Gambe per tavolo fisso
Set 4 legs for fixed table

Code	 L mm	 pcs	 kg	 min
80B3K750G	750	4	3	20

Finiture

Finishes

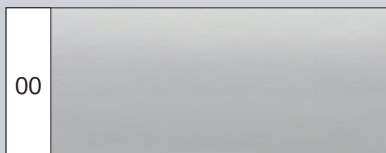

Alluminio anodizzato naturale
Natural anodised aluminum

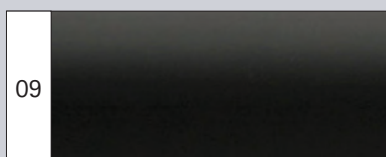

Anodizzato nero spazzolato
Black brushed anodised

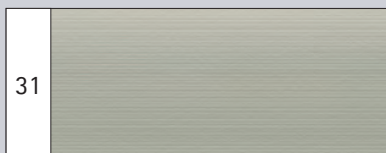

Anodizzato inox spazzolato
Olive gray brushed anodised

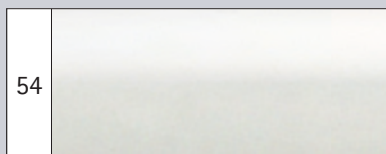

Alluminio verniciato bianco opaco
Matt white varnished aluminum

Per una reale valutazione, contattare il nostro ufficio tecnico-commerciale.
For a more precise colour evaluation, please contact our technical-commercial department.

