

ellelipi  
1 9 5 4

CATALOGUE 2021

elletipi  
1 9 5 4

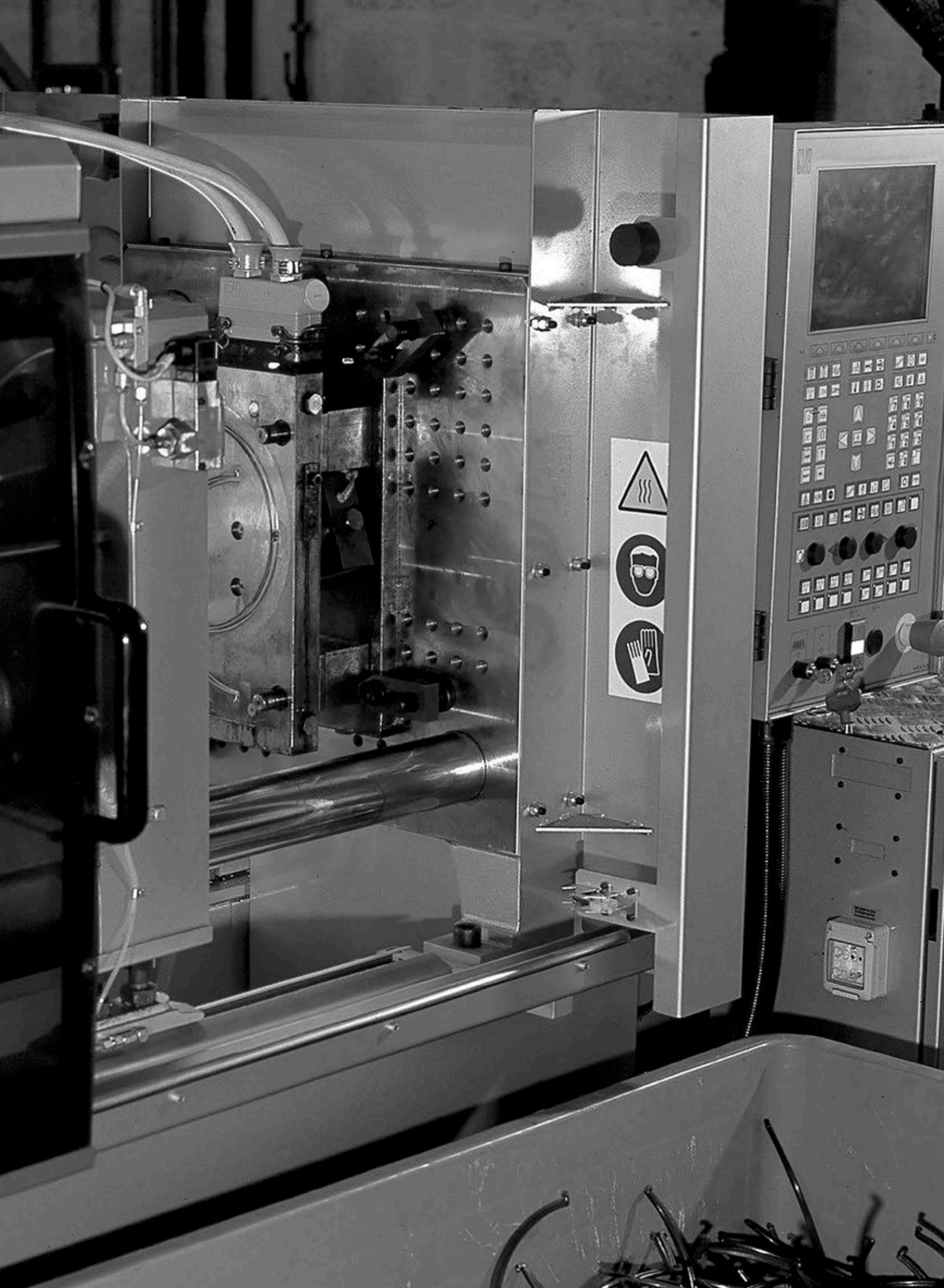

**Elletipi, un nome, una firma,  
una garanzia**

Elletipi inizia la sua attività nel 1954 dedicandosi allo stampaggio delle materie plastiche. Sempre attenta alle evoluzioni del mercato e alle nuove tendenze estetiche, nel corso degli anni l'azienda sceglie di specializzarsi nella produzione di componenti per mobili da cucina. Elletipi, è tra i leader nel settore, si distingue per la ricerca continua di soluzioni tecniche originali dal design innovativo, avvalendosi del reparto interno di sviluppo del prodotto.

Alcuni prodotti di questo catalogo sono stati sviluppati con l'architetto Giuseppe Mincoelli di Lineaguida.

**Elletipi, a name, a company  
design, a guarantee**

Elletipi started trading in 1954, dedicating its business activities to plastic moulding. The company has always reacted to market changes and new aesthetic trends, and over the years it decided to specialise in the production of components for kitchen cabinets. Elletipi, a leader in its field, distinguishes itself by the constant search for original technical solutions with innovative design, through the activities of the internal product development department. Some of the products in this catalogue were developed with the architect Giuseppe Mincoelli of "Lineaguida".

**Elletipi, un nombre, una  
empresa, una garantía**

Elletipi inicia su actividad en 1954 dedicándose al estampado de los materiales plásticos. Siempre atenta a las evoluciones del mercado y a las nuevas tendencias estéticas, a lo largo de los años la empresa opta por especializarse en la producción de componentes para muebles de cocina.

Elletipi, entre los líderes del sector, se distingue por la búsqueda continua de soluciones técnicas originales con un diseño innovador, sirviéndose de un taller interno de fabricación del producto. Algunos productos de este catálogo han sido creados con el arquitecto Giuseppe Mincoelli de Lineaguida.

# VISION

## Siamo ricchi di attenzioni

Possono sembrare semplici oggetti, ma noi dedichiamo un'estrema attenzione alla loro progettazione per fare la differenza e rendere piacevole e funzionale il loro utilizzo in cucina.

Poiché sappiamo che ogni cucina ha il proprio stile proponiamo soluzioni e finiture diverse dal design classico al moderno.

## We pay a lot of attention

They may look like simple objects, but we dedicate extreme attention to their design to make a difference and make their use in the kitchen pleasant and functional.

Since we know that every kitchen has its own style, we offer solutions and finishes ranging from classic models to modern design.

## Nos encantan las atenciones

Pueden parecer objetos simples, pero dedicamos un cuidado extremo a su diseño para marcar la diferencia y hacer que su uso en la cocina resulte agradable y funcional. Como sabemos que cada cocina tiene su propio estilo, proponemos soluciones y acabados diferentes que van del diseño clásico al moderno.

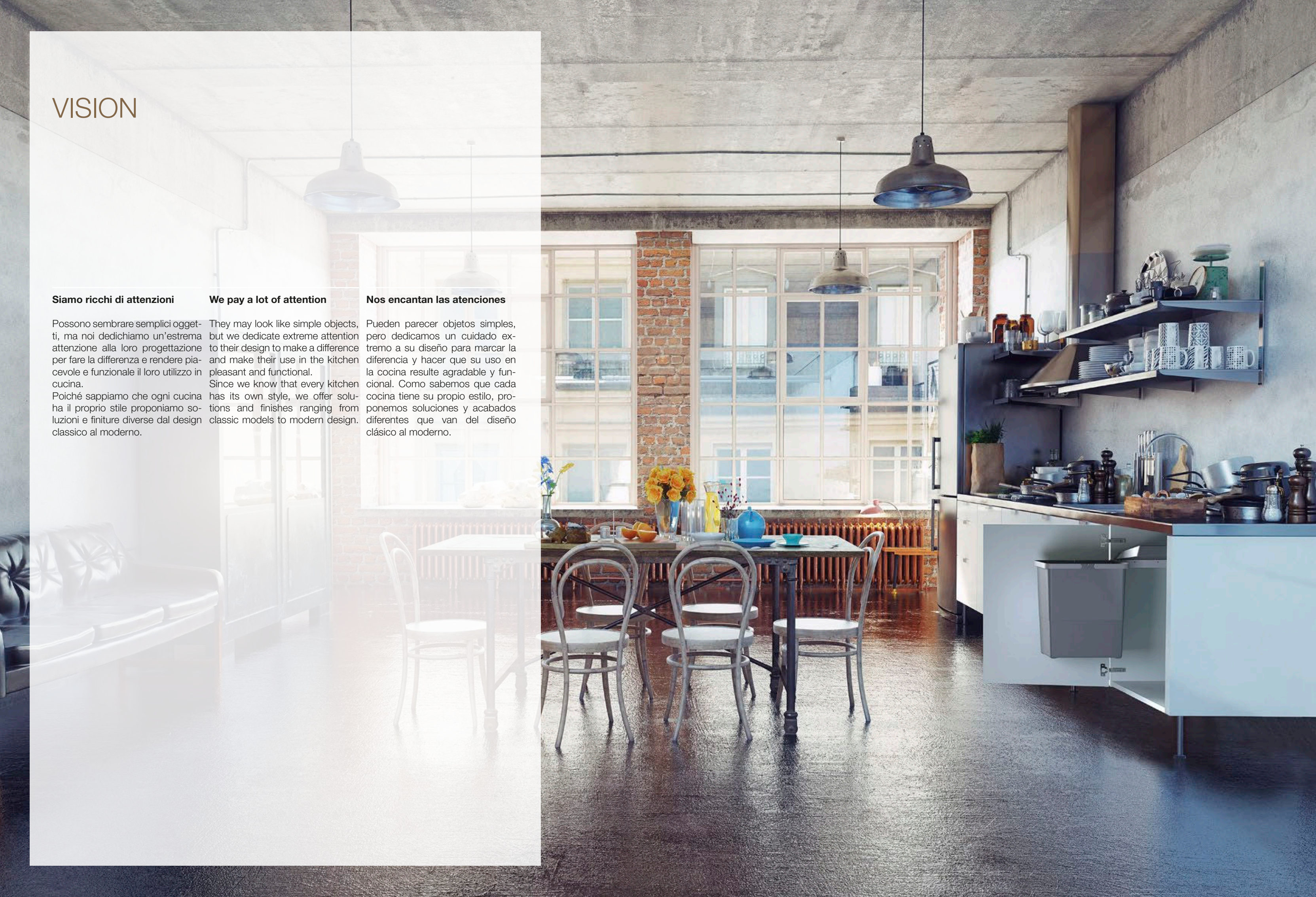

# MISSION

## Siamo affidabili

La cucina è il luogo più vissuto della casa, dove ci si incontra con la famiglia, gli amici. Per questo anche un semplice accessorio come una pattumiera, un portaposate, uno scolapiatti, racconta chi siamo, del nostro atteggiamento nei confronti dell'ambiente che ci circonda. Da sempre Elletipi è attenta alle esigenze dei propri clienti. Più di 50 anni di esperienza, continui investimenti in tecnologia, formazione del personale, ricerca e sviluppo, questi sono i nostri punti di forza.

## We are reliable

The kitchen is the most lived-in room in the house, where people gather with family and friends. This is why even a simple accessory like a dustbin, a cutlery tray, or a dish drainer, says something about us, about our attitude towards the environment that surrounds us. Elletipi is always attentive to the needs of its customers. More than 50 years' experience, continuous investments in technology, staff training, and research and development; these are our strengths.

## Se puede confiar en nosotros

La cocina es el lugar donde más tiempo se pasa en la casa, donde nos reunimos con la familia, los amigos. Por esto, incluso un simple accesorio como un cubo de basura, una bandeja para cubiertos, un escurrplatos, dice quiénes somos, cuál es nuestra actitud con respecto al ambiente que nos rodea. Desde siempre, Elletipi está atenta a las exigencias de sus clientes. Más de 50 años de experiencia, continuas inversiones en tecnología, formación del personal, investigación y desarrollo, éstos son nuestros puntos fuertes.





**City**  
10



**Street 2.0**  
18



**Ecofil**  
24



**Tower**  
30



**Twist**  
34

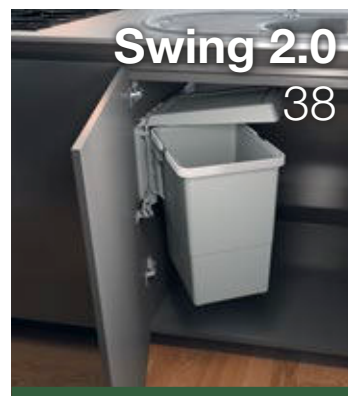

**Swing 2.0**  
38

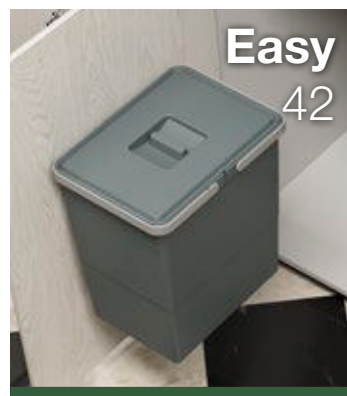

**Easy**  
42



**Ring**  
46

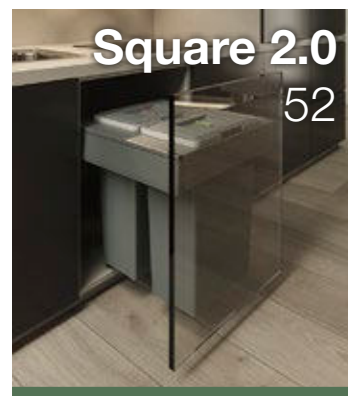

**Square 2.0**  
52



**Block 2.0**  
60



**Block U-Sink**  
66



**Block U-Top**  
70



**Free Form**  
74



**Metropolis**  
80



**Compo Evo**  
88



**Wizard X**  
92

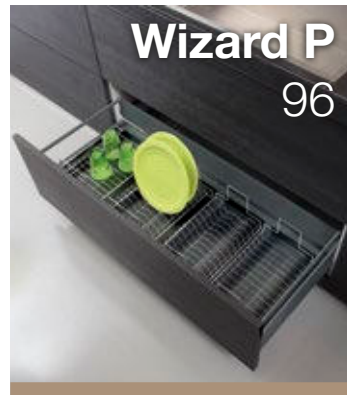

**Wizard P**  
96



**Wood Line**  
100



**Flexo**  
106



**Uppo**  
112



**Bridge**  
116



**Cover Box**  
122



**Bag Box**  
128



**Estrazione frontale**  
*Pull out*  
**Extracción frontal**



**Girevole per anta**  
*Swing out for door cabinets*  
**Giratorio para puerta**



**Raccoglitore integrato**  
*Door front fixations*  
**Basura integrada**



**Raccoglitore sottolavello**  
*Undersink collector*  
**Disipador de colector**



**Raccoglitore da cestone**  
*Under drawer wastebins*  
**Basura para distribuidores**



**Portaposate**  
*Cutlery trays*  
**Bandejas para cubiertos**



**Scolapiatti**  
*Dish drainers*  
**Escurreplatos**



**Contenitori**  
*Bins*  
**Contenedores**

# City



Inconfondibile sistema ad estrazione totale per la raccolta differenziata dal design originale.

Accurato studio di linee e forme per un prodotto perfettamente ergonomico e di facile utilizzo, nato dalla collaborazione con "Lineaguida"

#### Caratteristiche:

1. Prodotto in plastica completamente riciclabile.
2. Guide ad estrazione totale in metallo.
3. Fornito in 3 larghezze e 2 profondità.
4. Sportello a ribalta, unico nel suo genere, per gettare i rifiuti di piccole dimensioni.
5. Ripiano superiore utilizzabile come portaoggetti (detersivi, spugne...).
6. Tutte le pattumiere sono dotate di un secchio con coperchio con filtro antiodore (rigenerabile con lavaggio fino a 50 volte).
7. Fianco sagomato salva spazio.
8. Semplicità di installazione con solo 4 viti.

A unique system for complete removal of waste that needs to be separated, with an original design. Careful study of the design and shapes to make a product that is totally ergonomic and easy to use, developed in collaboration with "Lineaguida".

#### Features:

1. Fully recyclable plastic product.
2. Runners and extraction device made only of metal.
3. Supplied in 3 widths and 2 depths.
4. A unique hatch with a flap to dispose of small pieces of waste.
5. Upper shelf that can be used to keep objects (detergents, sponges, etc.).
6. All the bins have a bucket and a lid with an odour filter (which can be regenerated by washing for up to 50 times).
7. Space saving shaped side.
8. Easy to assemble with just 4 screws.

Inconfundibile sistema de extracción total para la recogida selectiva de original diseño.

Esmerado estudio de líneas y formas para un producto perfectamente ergonómico y de fácil uso, nacido de la colaboración con "Lineaguida".

#### Características:

1. Producto de plástico completamente reciclable.
2. Guías de extracción total de metal.
3. Se entrega en 3 anchos y 2 profundidades.
4. Puerta con solapa, única en su género, para tirar los desechos de pequeño tamaño.
5. Tabla superior que se puede usar como porta-objetos (detergentes, estropajos...).
6. Todos los cubos de basura llevan un cubo con tapa y filtro anti-olor (regenerable con lavado hasta 50 veces).
7. Lado moldeado para ahorrar espacio.
8. Instalación simple con sólo 4 tornillos.



# City



Fianco sagomato salva spazio  
Space saving shaped sides  
Lado moldeado para ahorrar espacio



Sportello a ribalta per rifiuti di piccole dimensioni  
A hatch which flips open for the disposal of small waste  
Puerta con solapa para desechos de tamaño pequeño



Vaschetta superiore utilizzabile come portaoggetti  
Upper tray for holding objects  
Cubeta superior utilizable como porta-objetos





# City



Disponibile in tre larghezze 28 cm. 35 cm. 52 cm. e due profondità 42 cm. e 47 cm

Available in three widths 28 cm, 35 cm, 52 cm and two depths 42 cm and 47 cm

Disponibile en tres anchos 28 cm. 35 cm. 52 cm. y dos profundidades 42 cm. y 47 cm

	C97		M
	5		P
	1		46X43X29
	30		80X120X240
	40		

h.44  
l.29 p.43

12 8



PTA 3040A

	C97		M
	5		P
	1		46X43X29
	30		80X120X240
	40		

h.44  
l.29 p.43

18



PTA 3040B

	C97		M
	5,5		P
	1		46X48X29
	30		80X120X240
	40		

h.44  
l.29 p.48

18 8



PTA 3045A

	C97		M
	5,5		P
	1		46X48X29
	30		80X120X240
	40		

h.44  
l.29 p.48

12 12



PTA 3045B

	C97		M
	6		P
	1		46X48X29
	30		80X120X240
	40		

h.44  
l.29 p.48

8 8 8



PTA 3045C



PTA 4040A

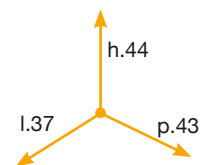

C97 M  
 5,5 P  
 1 46X43X36  
 25 80X120X240

18 12

C97 M  
 7 P  
 1 46X43X53  
 20 100X120X240

12 12 8 8

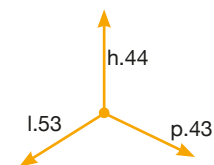

PTA 5040A



PTA 4040B



C97 M  
 6 P  
 1 46X43X36  
 25 80X120X240

12 8 8

C97 M  
 7,5 P  
 1 46X48X53  
 20 100X120X240

12 12 12 12

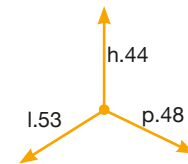

PTA 5040B

PTA 4045A

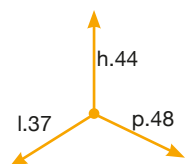

C97 M  
 6,5 P  
 1 46X48X36  
 25 80X120X240

18 8 8

C97 M  
 7,5 P  
 1 46X48X53  
 20 100X120X240

18 18 8 8

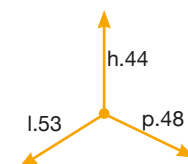

PTA 5045A

PTA 4045B

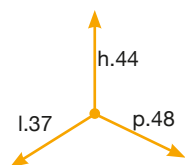

C97 M  
 6,5 P  
 1 46X48X36  
 25 80X120X240

18 18

C97 M  
 7,5 P  
 1 46X48X53  
 20 100X120X240

18 12 12 8

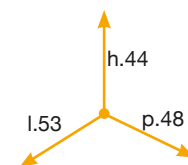

PTA 5045B

PTA 4045C

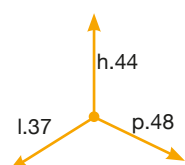

C97 M  
 7 P  
 1 46X48X36  
 25 80X120X240

8 8 8 8

# Street 2.0



Sistema ad estrazione frontale in acciaio inox lucido AISI 430 per la raccolta differenziata. Design lineare e minimale, massima cura nei dettagli sia tecnici che estetici per il prodotto ELLETIPI top di gamma

Front Extraction system in polished stainless steel AISI 430 for the waste separation. Linear and minimalist design, utmost care in both technical and aesthetic details for the Elletipi product top of the range.

Sistema de extracción frontal de acero inoxidable brillante AISI 430 para recogida selectiva. Diseño lineal y minimalista, muy atento a los detalles, tanto técnicos como estéticos, para el producto top de gama de Elletipi.

## Caratteristiche:

1. In acciaio inox completamente riciclabile.
2. Guide in metallo ad estrazione totale con soft-closing.
3. Fornito in differenti larghezze, altezze e profondità.
4. Tutte le pattumiere sono dotate di un secchio con coperchio con filtro divora-odore (rigenerabile con lavaggio fino a 50 volte).
5. Robusta struttura interna in lamiera di acciaio zincato verniciato bianco.
6. Sportello frontale scatolato (con possibilità di personalizzazioni).
7. Semplicità di installazione con sole 4 viti.
8. Facile da pulire.

## Features:

1. Fully recyclable stainless steel product.
2. Metal ball bearing sliders with total extraction with soft-closing.
3. Supplied in different widths, heights and depths.
4. All waste bins have a bin with lid with anti odour filter (regenerable by washing up to 50 times)
5. Robust internal structure in white painted galvanized steel sheet.
6. Front door boxed (with the possibility of customization)
7. Easy installation with only 4 screws.
8. Easy to clean.

## Características:

1. De acero inoxidable, completamente reciclable.
2. Guías de metal de extracción total con soft-closing.
3. Disponible en diferentes anchos, altos y profundidades.
4. Todos los cubos de basura cuentan con un recipiente con tapa con filtro antiolor (lavándolo puede reutilizarse hasta 50 veces).
5. Sólida estructura interna de chapa de acero cincado pintada de blanco.
6. Compuerta frontal embutida (se puede personalizar).
7. Fácil de instalar, con solo 4 tornillos.
8. Fácil de limpiar.



Struttura in acciaio inox lucido  
*Structure in polished stainless steel*  
Estructura de acero inoxidable brillante

Coperchio con filtro rigenerabile divora odore  
*Lid with odor filter devours*  
Tapa con filtro antiolor

Guide in metallo ad estrazione totale con soft-closing  
*Fully extractable metal runners with soft-closing*  
Metal guías extracción total con retorno soft-closing

Sportello in acciaio realizzato con rifiniture di precisione  
*Front door box made with precision finishes*  
Compuerta frontal embutida realizada con acabados de precisión

## Street 2.0



Robusta struttura interna in lamiera di acciaio zincato verniciato bianco  
*Robust internal structure in white painted galvanized steel sheet*  
Sólida estructura interna de chapa de acero cincado pintada de blanco

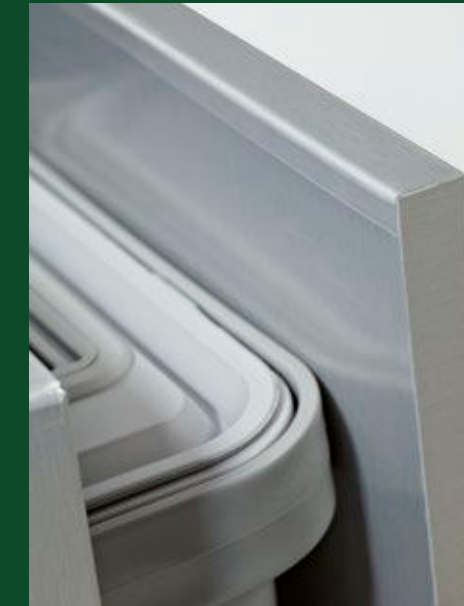

Sportello frontale scatolato (con possibilità di personalizzazioni)  
*Front door boxed (with the possibility of customization)*  
Compuerta frontal embutida (se puede personalizar)



Un prodotto elegante e raffinato dal design lineare  
*An elegant and refined product with a linear design*  
Un producto elegante y refinado con diseño lineal





PA2 INL423033A

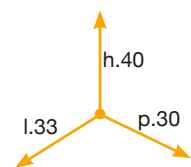

C97 MRS  
 9,5 Ax  
 1 42X44X27  
 30 80X120X220  
 40

18

C97 MRS  
 11 Ax  
 1 42X49X34  
 25 80X120X220  
 40

18 12

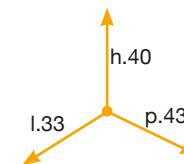

PA2 INL423033B



PA2 INL423033B

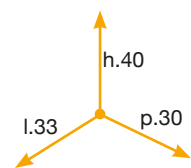

C97 MRS  
 10 Ax  
 1 42X49X27  
 30 80X120X220  
 40

8 8

C97 MRS  
 11,5 Ax  
 1 42X43X49  
 20 100X120X220  
 60

12 12 8 8

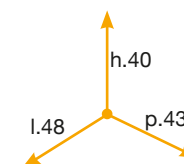

PA2 INL423033B

PA2 INL424326A

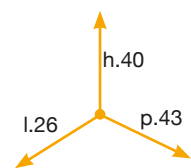

C97 MRS  
 10 Ax  
 1 42X49X27  
 30 80X120X220  
 40

12 8

PA2 INL424333A

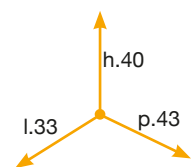

C97 MRS  
 10,5 Ax  
 1 42X44X34  
 25 80X120X220  
 40

12 8 8



Fornito in differenti larghezze, altezze e profondità. Su richiesta è possibile realizzare STREET 2.0 anche in altre dimensioni  
 Supplied in different widths, heights and depths. On request it is possible to realize STREET 2.0 in other dimensions  
 Disponible en diferentes anchos, altos y profundidades. Se puede fabricar STREET 2.0 en otras medidas por encargo

# Ecofil



Linea di pattumiere da base realizzate in filo d'acciaio cromato per per la raccolta differenziata. Prodotto semplice, ma allo stesso tempo estremamente robusto, durevole e con un ottimo rapporto qualità/prezzo. Offre un'ampia gamma di soluzioni grazie all'utilizzo della serie di contenitori Cover Box.

#### Caratteristiche:

1. Struttura in filo d'acciaio cromato completamente riciclabile.
2. Guide a sfera ad estrazione totale in acciaio
3. Fornito in differenti larghezze, altezze e profondità.
4. Robusto e durevole nel tempo.
5. Versatile e di poco ingombro (grazie al semplice telaio in metallo senza carenatura)
6. Semplicità di installazione con sole 4 viti.
7. Facile da pulire.

Line of build in waste bins systems made of chrome plated steel wire for waste separation. Basic product, but at the same time extremely strong, durable and with an excellent quality/price ratio. It offers a wide range of solutions thanks to the use of the Cover Box series containers.

#### Features:

1. Frame in recyclable chromed steel wire.
2. Steel ball bearing sliders with a full extension.
3. Supplied in different widths, heights and depths.
4. Strong and durable.
5. Versatile and space-saving (thanks to the simple metal frame without outside hull)
6. Easy installation with only 4 screws.
7. Easy to clean.

Línea de cubos de basura de base fabricados en hilo de acero cromado para recogida selectiva. Producto simple pero al mismo tiempo extremadamente sólido, duradero y con una excelente relación calidad/precio. Ofrece una amplia gama de soluciones, gracias a la utilización de la serie de contenedores Cover Box.

#### Características:

1. Estructura de hilo de acero cromado, completamente reciclable.
2. Guías de bolas de acero totalmente extraíbles.
3. Disponible en diferentes anchos, altos y profundidades.
4. Sólido y duradero a lo largo del tiempo.
5. Versátil y de dimensiones reducidas (gracias al simple bastidor de metal sin revestimiento).
6. Fácil de instalar, con solo 4 tornillos.
7. Fácil de limpiar.



Facile installazione con 4 viti  
*Easy to assemble with 4 screws*  
 Instalación fácil con 4 tornillos

Contenitori di facile pulizia  
*Easy to clean containers*  
 Contenedores fáciles de limpiar



Disponibile in varie altezze, larghezze e profondità  
*Available in various heights, widths and depths*  
 Disponible en varias alturas, anchuras y profundidades

Guida ad estrazione totale  
*Runners for full extraction*  
 Guía de extracción total

Filo in acciaio cromato  
*Chromed steel wire*  
 Alambre de acero cromado

# Ecofil



C97	M			PF02 A
4,5	Acr			
1	43X47X35			
32	80X120X225			
40		18	18	

C97	M			PF02 B
5	Acr			
1	43X47X35			
32	80X120X225			
40		18	8	8

C97	M			PF02 C
5	Acr			
1	43X47X35			
32	80X120X225			
40		8	8	8



PF01 34A1

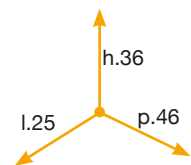

18 8

	C97		M
	5 kg		Acr
	1		42X46X24
	30		80X120X220
	30		

	C97		M
	6,5 kg		Acr
	1		42X46X31
	25		80X120X220
	40		

8 8 8 8

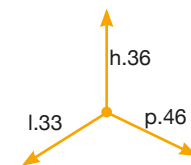

PF01 34B3



PF01 34A2



12 12

	C97		M
	5 kg		Acr
	1		42X46X24
	30		80X120X220
	30		

	C97		M
	6,5 kg		Acr
	1		42X46X31
	25		80X120X220
	40		

12 12 12

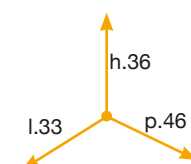

PF01 34B4

PF01 34A3

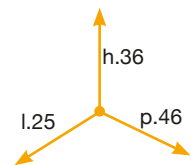

8 8 8

	C97		M
	5,5 kg		Acr
	1		42X46X24
	30		80X120X220
	30		

	C97		M
	4,5 kg		Acr
	1		42X42X24
	40		80X120X220
	30		

18



PF01 34C1

PF01 34B1

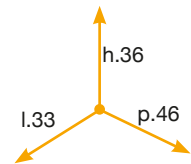

18 8 8

	C97		M
	6 kg		Acr
	1		42X46X31
	25		80X120X220
	40		

	C97		M
	8,5 kg		Acr
	1		52X46X31
	20		80X120X218
	40		

24 8 8

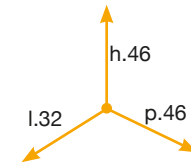

PF01 44B1

PF01 34B2

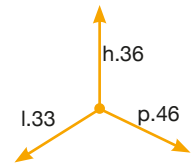

18 18

	C97		M
	5,5 kg		Acr
	1		42X46X31
	25		80X120X220
	40		

	C97		M
	7,5 kg		Acr
	1		52X46X31
	20		80X120X218
	40		

24 24

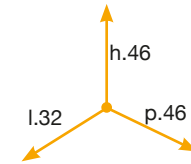

PF01 44B2



# Tower



Linea di pattumiere per la raccolta differenziata ad estrazione a carrello. Apertura automatica del coperchio all'estrazione.

Ampia scelta di finiture in plastica, acciaio inox, alluminio o lamiera pre-verniciata bianca. Disponibili in più moduli (da 1 a 4 secchi).

#### Caratteristiche:

1. Prodotto in materiali completamente riciclabile.
2. Guide nascoste e ad estrazione totale in metallo.
3. Fornito in diverse larghezze, altezze e profondità.
4. Semplicità installazione con solo 4 viti.

A dustbins product line for the separate collection of waste with an extractable basket. Automatic opening of the lid when the bin is extracted.

Wide choice of finishes: plastic, stainless steel, aluminium or white pre-painted steel. Available in a number of modules (with from 1 to 4 buckets).

#### Features:

1. Product made of fully recyclable materials.
2. Hidden metal runners for full extraction.
3. Supplied in different widths, heights and depths.
4. Easy to assemble with only 4 screws.

Línea de cubos de basura para la recogida selectiva con extracción de carrito. Apertura automática de la tapa en la extracción.

Amplia variedad de acabados de plástico, acero inoxidable, aluminio o chapa previamente barnizada blanca. Disponibles en varios módulos (de 1 a 4 cubos).

#### Características:

1. Producto en materiales completamente reciclables.
2. Guías ocultas y de extracción total en metal.
3. Se entrega en diferentes anchos, alturas y profundidades.
4. Instalación simple con sólo 4 tornillos.





PAI609/1

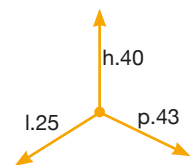

		P
	4	Ax+P
	1	41,5X26X42
	40	85X120X225

17



		P
	5,5	Ax+P
	1	49,5x29,5x44
	30	80X120X230

16 10

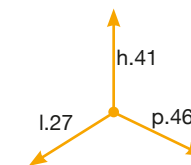

PAI605/1

PAL609/1 ALL

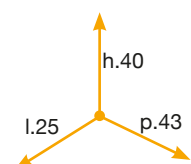

		P
	3,7	Al+P
	1	41,5X26X42
	40	85X120X225

17



		P
	5,3	Al+P
	1	49,5x29,5x44
	30	80X120X230

16 10



PAL605/1 ALL

PAP609/1

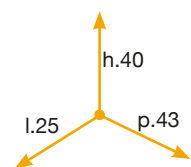

			P
	3,4		P
	1		41,5X26X42
	40		85X120X225

17



			P
	4,5		P
	1		49,5x29,5x44
	30		80X120X230

16 10

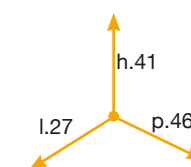

PAP605/1



# Twist



Pattumiere da inserire nelle basi lavello ad angolo di 1050 x 600 e 1200 x 600.

Sono caratterizzate da una struttura portante in metallo verniciato e cestini portaoggetti in metallo cromato oltre ai secchi della serie CoverBox.

#### Caratteristiche:

1. Struttura autoportante.
2. Facile installazione con l'utilizzo di 12 viti.
3. Estrazione totale con ritorno ammortizzato.
4. Apertura totale in quattro fasi.
5. Secchi della linea CoverBox.
6. Facile da pulire.

Dustbins to be fitted in the corner sink unit with 1050x600 and 1200x600 angles.

They have a painted metal supporting frames and chrome metal baskets for storing objects in addition to the Coverbox series buckets.

#### Features:

1. Self-supporting frame.
2. Easy to assemble with 12 screws.
3. Full extraction with cushioned return.
4. Full opening in four phases.
5. Coverbox product line buckets.
6. Easy to clean.

Cubos de basura para introducir en la parte baja del fregadero de esquina de 1050x600 y 1200x600.

Se caracterizan por una estructura portante de metal barnizado y cestos porta-objetos de metal cromado además de los cubos de la serie CoverBox.

#### Características:

1. Estructura autoportante.
2. Fácil instalación usando 12 tornillos.
3. Extracción total con retorno amortizado.
4. Apertura total en cuatro fases.
5. Cubos de la línea CoverBox.
6. Fácil de limpiar.



# Twist



Contenitori di facile pulizia  
Easy to clean containers  
Contenedores fáciles de limpiar

Struttura autoportante  
Self-supporting frame  
Estructura autoportante

Facile installazione con 12 viti  
Easy to assemble with 12 screws  
Instalación fácil con 12 tornillos

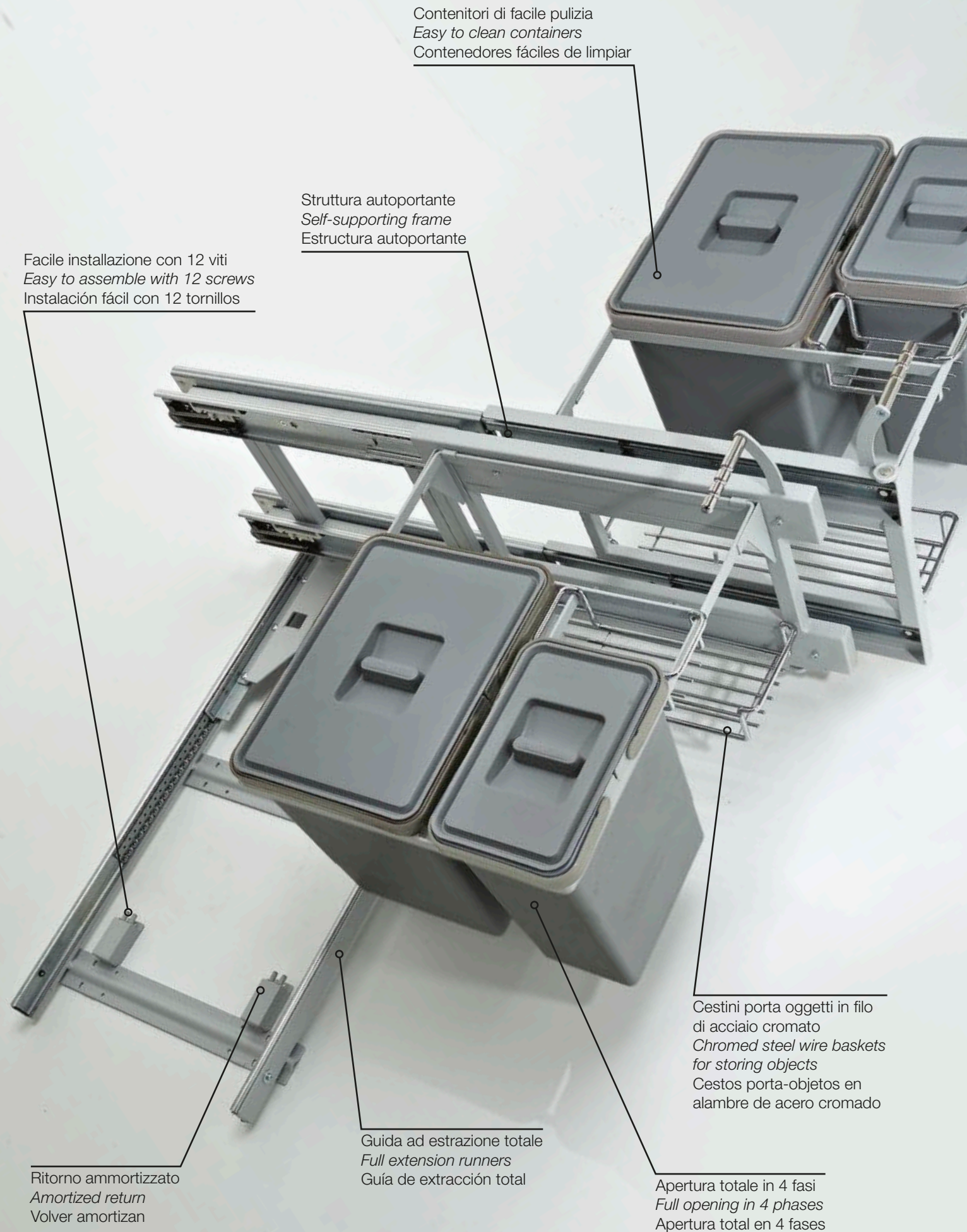

Cestini porta oggetti in filo di acciaio cromato  
Chromed steel wire baskets for storing objects  
Cestos porta-objetos en alambre de acero cromado

Guida ad estrazione totale  
Full extension runners  
Guía de extracción total

Ritorno ammortizzato  
Amortized return  
Volver amortizan

Apertura totale in 4 fasi  
Full opening in 4 phases  
Apertura total en 4 fases

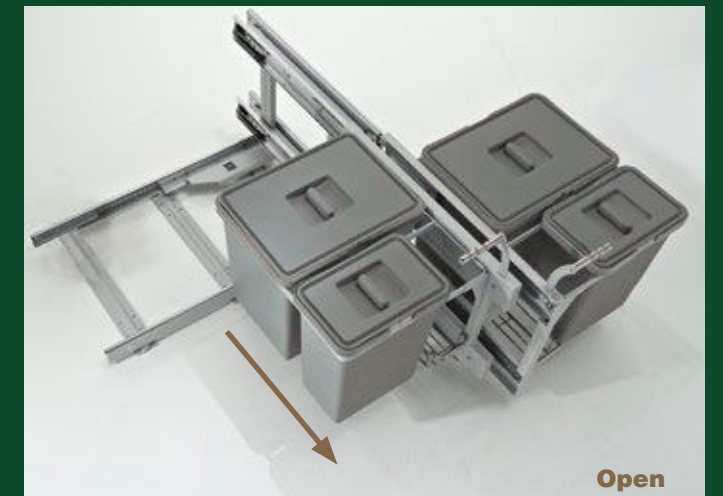
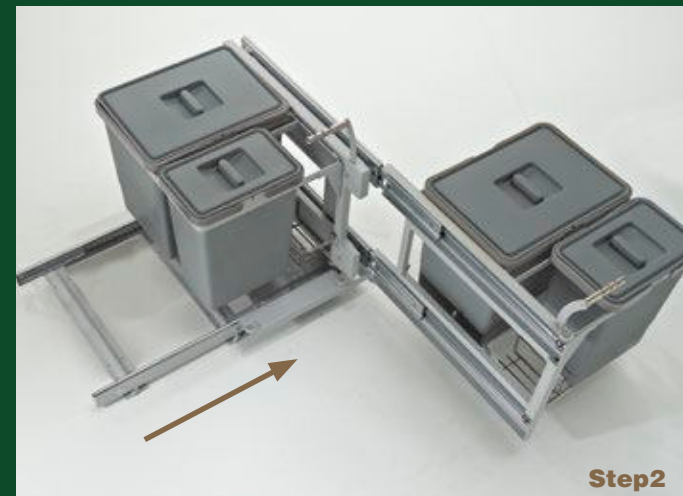
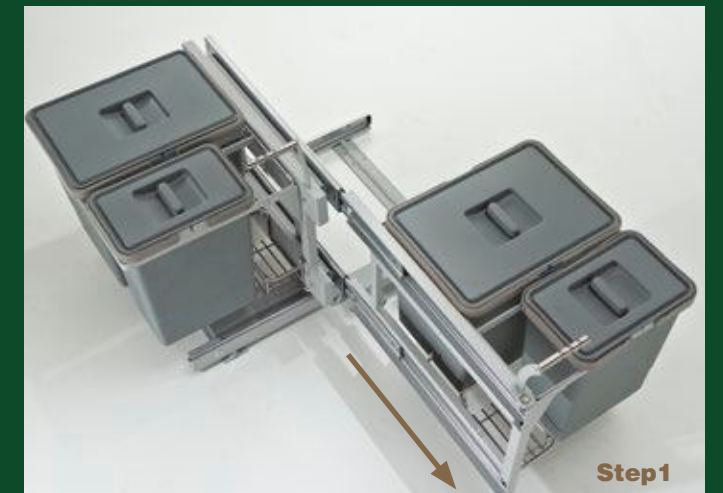

Codice DX = scorrimento carrello interno base verso destra / Codice SX = scorrimento carrello interno base verso sinistra  
Code DX = sliding structure inside the base with movement to the right / Code SX = sliding structure inside the base with movement to the left  
Código DX = carro dentro de la base deslizante hacia la derecha / Código SX = deslizamiento Compras base interior a la izquierda

C97	MRS
25,5	Acr+Av
1	47X46,5X57
16	80X120X215
105	40

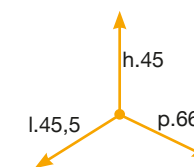

15 15 6 6

Per base angolo destra PF09 105 DX - per base angolo sinistra PF09 105 SX  
For PF09 105 DX right corner base - for PF09 105 SX left corner base  
Para la parte baja de la esquina derecha PF09 105 DX - para la parte baja de la esquina izquierda PF09 105 SX



PF09 105 - -

C97	MRS
27,5	Acr+Av
1	47X46,5X93
16	80X120X215
120	60

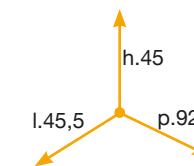

15 15 6 6

Per base angolo destra PF09 120 DX - per base angolo sinistra PF09 120 SX  
For PF09 120 DX right corner base - for PF09 120 SX left corner base  
Para la parte baja de la esquina derecha PF09 120 DX - para la parte baja de la esquina izquierda PF09 120 SX



PF09 120 - -

# Swing 2.0



Il sistema girevole ad Apertura Automatica con l'anta è un sistema innovativo che permette la chiusura ermetica del contenitore. Completamente realizzato in polimeri di Polipropilene e Nylon caricato in fibra di vetro, oltre che funzionale si presenta come estremamente robusto e durevole nel tempo. Un prodotto semplice dal design minimale, che nasce da importanti analisi di utilizzo in risposta alle richieste sia dei rivenditori, sia dei clienti finali. Studiato per scaricare tutto il peso del contenitore sul fianco della base anziché sullo sportello e non ledere nel tempo l'anta della cucina. Il sistema di trascinamento è adattabile a tutte le tipologie di anta grazie ad un pratico sistema che ne permette la regolazione. L'oggetto può essere montato sia sul fianco destro che sul fianco sinistro della base, o sovrapposto. E' Disponibile con contenitori da 12, 15, 18 e da 24 litri, i quali per le proprie caratteristiche intrinseche, possono ulteriormente essere suddivisi per effettuare raccolta differenziata all'interno di un solo contenitore.

#### Caratteristiche:

1. Robusto supporto girevole del secchio in polimeri caricati.
2. Apertura e chiusura automatica tramite l'apertura dell'anta.
3. Disponibile per contenitori da 24, 18, 15 e 12 litri.
4. Idoneo al montaggio sia sul fianco destro che sul fianco sinistro della base.
5. Idoneo per tutte cerniere (consente le massime aperture).

The Automatic Opening with the door is an innovative system that allows the container to be sealed. Completely made of Polypropylene and Nylon with fiberglass, as well as functional it looks extremely solid and durable over time. A basic product with minimal design, a result from an usage analysis in response to the demands of retailers and end customers. Designed to relieve the weight of the container on the kitchen base wall instead of the door and will not damage the kitchen door in time. The pull out system is suitable for all types of doors thanks to a practical system that allows its adjustment. The system can be mounted either on the right side or on the left side of the base, or one on top of the other. It is available with 12, 15, 18 and 24 liters bins, which for their own intrinsic characteristics can be further subdivided into a waste separate system within a single container.

#### Caratteristiche:

1. Robust rotating bucket support made out of reinforced polymers.
2. Automatic opening and closing lid by opening the door.
3. Available for containers with a capacity of 24, 18, 15 and 12 liters.
4. Available on both the right and the left side of the kitchen base.
5. Suitable for all hinges (allows maximum openings).

El sistema giratorio de apertura automática con la puerta es un sistema innovador que permite el cierre hermético del contenedor. Completamente hecho de polipropileno y nylon reforzado de fibra de vidrio, además de ser extremadamente, es extremadamente robusto y duradero en el tiempo. Un producto simple con un diseño minimalista, que surge de un importante análisis de utilización en respuesta a las solicitudes de los distribuidores como de los clientes finales. Diseñado para descargar todo el peso del contenedor en el lado de la base en lugar de en la puerta y no dañar la puerta de la cocina con el uso diario. El sistema de arrastre es adaptable a todos los tipos de puertas gracias a un sistema práctico que permite a su regulación. El cubo se puede montar en el lado derecho o en el lado izquierdo de la base, o se puede superponer. Está disponible con contenedores de 12, 15, 18 y 24 litros, que, debido a sus características intrínsecas, pueden dividirse aún más para la recogida selectiva de basura dentro de un solo contenedor.

#### Características:

1. Soporte rotativo del cubo de polímero cargado muy robusto.
2. Apertura y cierre automáticos abriendo la puerta.
3. Disponible para cubos de 24, 18, 15 y 12 litros.
4. Adecuado para el montaje tanto en el lado derecho como en el lado izquierdo de la base.
5. Adecuado para todas las bisagras (permite aberturas máximas).



Apertura e Chiusura automatica tramite l'apertura dell'anta  
Automatic opening and closing lid by opening the door



Robusto supporto girevole del secchio  
in polimeri caricati  
Robust rotating bucket support made out  
of reinforced polymers

Disponibile per contenitori da 24, 18, 15 e 12 litri  
Available for containers with a capacity of 24, 18,  
15 and 12 liters

	C97		
	1,6		P
	1		47X26X34
	40		80X120X203

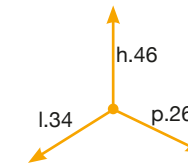

PBN ASG44

	C97		
	1,5		P
	1		37X26X34
	50		80X120X200

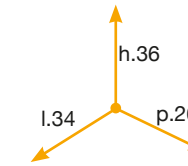

PBN ASG34

	C97		
	1,4		P
	1		31X26X34
	70		80X120X224

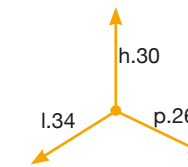

PBN ASG28

	C97		
	1,3		P
	1		31X26X34
	70		80X120X224

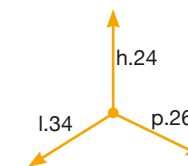

PBN ASG22



# Easy



Linea di pattumiere di Grande Capacità semplice ed economico. Il supporto in acciaio inox si fissa direttamente all'interno dell'anta e sullo stesso è possibile agganciare i contenitori della serie Cover Box.

#### Caratteristiche:

1. Supporto in acciaio inox completamente riciclabile.
2. Contenitori in polipropilene completamente riciclabile di 15, 18 e 24 litri.
3. I contenitori utilizzati permettono, all'occorrenza, di inserire 2 sacchetti all'interno di un solo contenitore.
4. Semplicità di installazione con sole 2 viti.
5. Facile da pulire.

Product line of waste bins simple and economic with a big capacity. The stainless steel support is fixed directly on the inside of the door and on the same it is possible to hook on the containers of Cover Box series.

#### Features:

1. Stainless steel support completely recyclable
2. Bins in completely recyclable thermoplastic polypropylene of 15, 18 and 24 liters
3. The containers we use allow, if necessary, to insert two inner bags on the inside of a single container
4. Easy installation with only 2 screws.
5. Easy to clean.

Línea de cubos de basura de Gran Capacidad, simple y económica. El soporte de acero inoxidable se fija directamente al interior de la puerta y en el mismo se pueden enganchar los contenedores de la serie Cover Box.

#### Características:

1. Soporte de acero inoxidable, completamente reciclable.
2. Contenedores de polipropileno completamente reciclables de 15, 18 y 24 litros.
3. Los contenedores utilizados permiten, si fuera necesario, introducir 2 bolsas dentro de un mismo contenedor.
4. Fácil de instalar, con solo 2 tornillos.
5. Fácil de limpiar.



Supporto in acciaio inox  
Stainless steel support  
Soporte de acero inoxidable

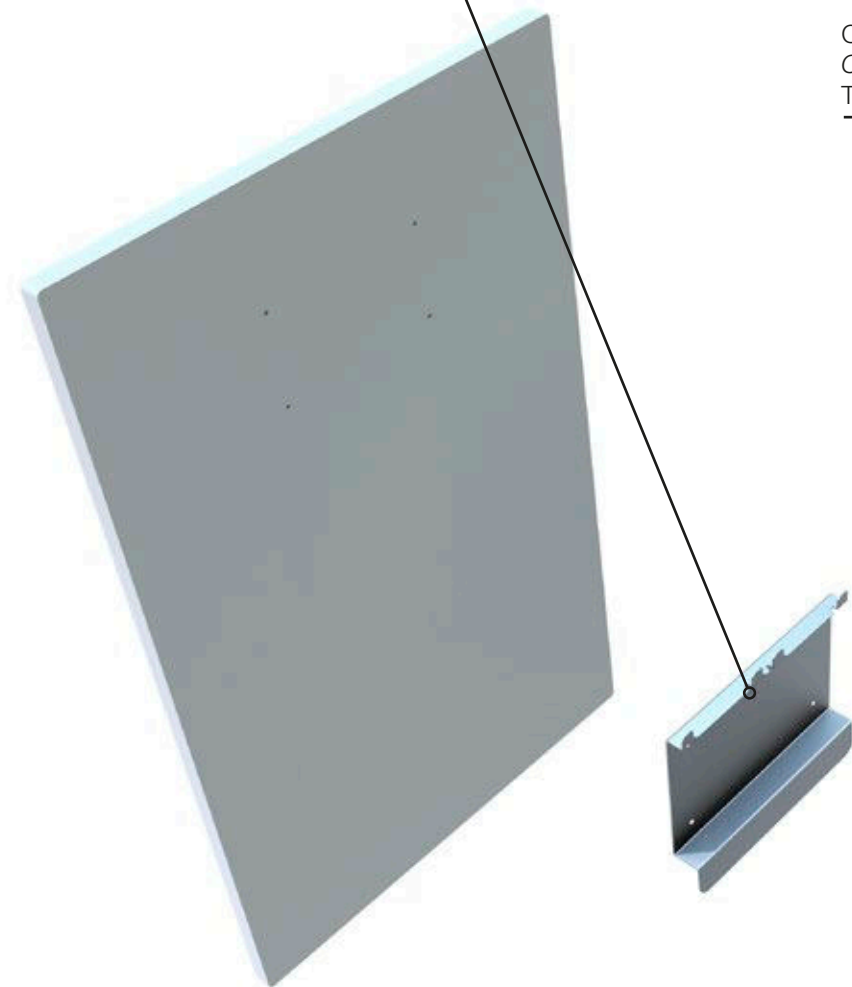

Coperchio in appoggio  
Cover in support  
Tapa que apoya

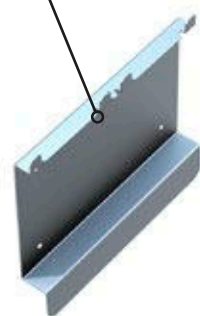

Incisione per l'eventuale  
inserimento di 2 sacchetti  
Engraving for the eventual  
inclusion of 2 inner bags  
Ranura para la posible  
introducción de 2 bolsas

Manici per l'estrazione e per il bloccaggio dei sacchetti  
Handles for the extraction and for the locking the inner bags  
Manijas para extraer y fijar las bolsas



C97

kg 1,7

P+Ax

1

54X23X33

44

80X120X231

45

24

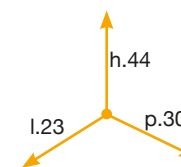

PBD SA SG44



C97

kg 1,6

P+Ax

1

35X23X33

55

80X120X205

45

18

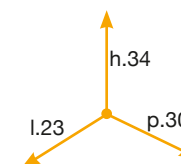

PBD SA SG34



C97

kg 1,5

P+Ax

1

38X23X33

55

80X120X205

45

15

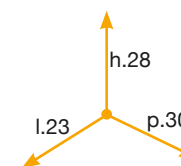

PBD SA SG28



# Ring



Linea di pattumiere rotonde fissate direttamente sul fianco del mobile.

A round dustbins product directly mounted on the side of the cabinet.

Línea de cubos de basura redondos fijados directamente a un lado del mueble.

## Caratteristiche:

1. Apertura automatica del coperchio all'apertura dell'anta.
2. Disponibile con finiture in acciaio lucido, alluminio quadrettato o plastica (bianco, sabbia, grigio).
3. Facile montaggio.
4. Secchi tondi da 10 o 12 litri.
5. Montaggio sul fianco destro o sinistro.

## Features:

1. Automatic lid opening when the door is opened.
2. Available in polished steel finishing, plastic or chequered aluminium (in white, sand, grey).
3. Easy to assemble.
4. 10 or 12 litre capacity round bins.
5. Can be mounted the right or left side.

## Características:

1. Apertura automática de la tapa al abrir la puerta.
2. Disponible con acabados en acero lúcido, aluminio cuadriculado o plástico (blanco, arena, gris).
3. Fácil montaje.
4. Cubos redondos de 10 o 12 litros.
5. Montaje en el lado derecho o izquierdo.



Apertura automatica del coperchio  
*Automatic lid opening*  
Apertura automática de la tapa

Finiture alluminio quadrettato acciaio inox, plastica  
*Aluminium chequered, stainless steel, or plastic finishes*  
Acabado en aluminio cuadrículado, acero inoxidable, plástico

Montaggio veloce con 8 viti  
*Quick assembly with 8 screws*  
Montaje rápido con 8 tornillos

Montaggio fianco destro o sinistro  
*Can be mounted on the right or left side*  
Montaje en el lado derecho o izquierdo

Capacità da 10 l. e 12 l.  
*10 L. or 12 L capacity*  
Capacidad de 10 y 12 L.

# Ring



Apertura con filo  
*Can be opened with a string*  
Apertura con cable



Apertura automatica  
*Automatic opening*  
Apertura automática



Plastica  
*Plastic*  
Plástico



Alluminio gofrato  
*Chequered aluminium*  
Aluminio cuadrículado



Acciaio inox  
*Stainless steel*  
Acero inoxidable

PP602/1

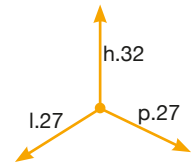

	C01		
	kg 1,4		P
	1		34X28X28
	72		90X120X214
<b>10</b>			

	kg 1,6		Al+P
	1		34X28X28
	72		90X120X214
<b>10</b>			

PP1606/1 ALL

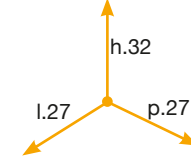

PP1607/1

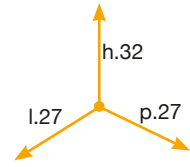

	kg 2,4		Al+P
	1		34X28X28
	72		90X120X214
<b>10</b>			

	kg 2,1		Al+P
	1		34X28X28
	72		90X120X214
<b>10</b>			

PP1606/1

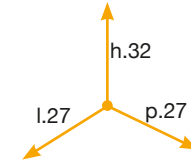

PP1607/1 12L

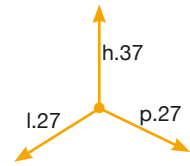

	kg 2,5		Al+P
	1		39X28X28
	60		90X120X205
<b>12</b>			

PP1607/1 ALL

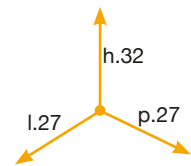

	kg 1,8		Al+P
	1		34X28X28
	72		90X120X214
<b>10</b>			

PP1607/1 ALL 12

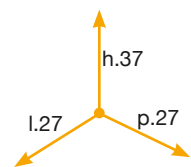

	kg 1,9		Al+P
	1		39X28X28
	60		90X120X205
<b>12</b>			

# Square 2.0

Linea di pattumiere per raccolta differenziata di Grande Capacità da cassetto con collegamento all'anta. Il sistema è composto da un telaio in lamiera di acciaio zincato verniciato a polveri epossidiche che si integra perfettamente nei cassetti di tutti i più importanti produttori, sostituendo il normale fondo in melaminico. Il sistema offre la possibilità di organizzare la raccolta differenziata in basi dedicate ed ottimizza lo spazio disponibile. La versione SQUARE 2.0 ha subito un restyling portando i contenitori a filo delle sponde dei cassetti. Per tutti i modelli è disponibile come accessorio il coperchio automatico che, dotato di cuscinetti scorrevoli, permette la chiusura/apertura automatica dei contenitori. La sede di alloggiamento dei contenitori è caratterizzata da un profilo imbutito che oltre ad irrobustire la struttura la rende anche più gradevole.

## Caratteristiche:

1. Struttura in lamiera di acciaio zincato verniciato a polveri epossidiche realizzata in un monoblocco.
2. Alloggiamento dei contenitori realizzati con profilo imbutito.
3. Il sistema prevede il fissaggio all'anta con possibilità di registro.
4. Sistema prodotto per i più importanti produttori di cassetti (BLUM®; HETTICH®; GRASS®; ..).
5. Contenitori in polipropilene completamente riciclabile da 8 a 43 litri (capacità complessiva fino a 86 litri).
6. Tutte le pattumiere sono dotate di un secchio con coperchio con filtro divora odore (rigenerabile con lavaggio fino a 50 volte).
7. Disponibile come optional il coperchio automatico per una chiusura ermetica dei contenitori.
8. Semplicità di installazione.
9. Facile da pulire.

Product line of Large Capacity waste bins for waste separation for drawers with fixation for the door front. The system consists of a metal galvanized steel frame epoxy powder painted that integrates perfectly in the drawers of all the major manufacturers, replacing the normal melamine bottom of the drawer. The system offers the possibility to organize the waste separation in dedicated kitchen bases and to optimize the available space. The SQUARE 2.0 version has undergone a makeover bringing the inner bins to top of the drawer sides. For all models is available an accessory namely the automatic lid that is equipped with sliding bearings, which allows the closing/opening automatically of the containers. The seat of accommodation of the containers is characterized by a deep-drawn profile which strengthens the structure makes gives it a clean aspect.

## Features:

1. Structure in galvanized sheet steel and epoxy powder painted realized in a single block.
2. Location for bins finished with a deep-drawn profile.
3. The system provides fixing to the front door with registry possibility.
4. Product system for the most important manufacturers of drawers (BLUM®; HETTICH®; GRASS®; ..).
5. Inner bins in recyclable polypropylene from 8 till 43 liters (total capacity up to 86 liters).
6. All waste bins have a bin with lid with anti odour filter (regenerable by washing up to 50 times).
7. Available as an optional an automatic cover for an closer.
8. Easy installation.
9. Easy to clean.

Línea de cubos de basura para recogida selectiva de Gran Capacidad de cajón con fijación a la puerta. El sistema está compuesto por un bastidor de chapa de acero cincado pintada con polvo epoxi que se integra perfectamente en los cajones de los principales fabricantes, sustituyendo el fondo de melamina habitual. El sistema ofrece la posibilidad de organizar la recogida selectiva en bases específicas y optimiza el espacio disponible. La versión SQUARE 2.0 ha sido rediseñada, llevando los contenedores hasta el borde de los cajones. Para todos los modelos está disponible como accesorio la tapa automática que, al contar con cojinetes deslizantes, permite la apertura y cierre automático de los contenedores. El compartimiento donde se alojan los contenedores se caracteriza por un perfil embutido que, además de volver más sólida la estructura, la hace más agradable.

## Características:

1. Estructura de chapa de acero cincado pintada con polvo epoxi fabricada en una sola pieza.
2. Alojamiento de los contenedores fabricados con perfil embutido.
3. El sistema prevé que se fije a la puerta con posibilidad de regulación.
4. Sistema producido para los principales fabricantes de cajones (BLUM®; HETTICH®; GRASS®; etc.).
5. Contenedores de polipropileno completamente reciclables de 8 a 43 litros (capacidad total de hasta 86 litros).
6. Todos los cubos de basura cuentan con un recipiente con tapa con filtro antiolor (lavándolo puede reutilizarse hasta 50 veces).
7. La tapa automática para un cierre hermético de los contenedores está disponible como opcional.
8. Fácil de instalar.
9. Fácil de limpiar.



# Square 2.0

Telaio studiato per i più importanti produttori di cassetti (BLUM®; HETTICH®; GRASS®; ecc.)  
 Frame studied for the most important manufacturers of drawers (BLUM®; HETTICH®; GRASS®; etc.)  
 Bastidor diseñado para los principales fabricantes de cajones (BLUM®; HETTICH®; GRASS®; etc.)

Alloggi dei contenitori realizzati con profilo imbutito  
 Location for bins finished with a deep-drawn profile  
 Alojamiento de los contenedores fabricados con perfil embutido

Telaio che sostituisce il fondo del cassetto  
 Frame, which replaces the bottom chipboard of the drawer  
 Bastidor que sustituye el fondo del cajón

Monoblocco in lamiera di acciaio zincato verniciato a polveri epossidiche  
 Single block in steel galvanized sheet and epoxy powder painted  
 Una sola pieza de chapa de acero cincado pintada con polvo epoxi

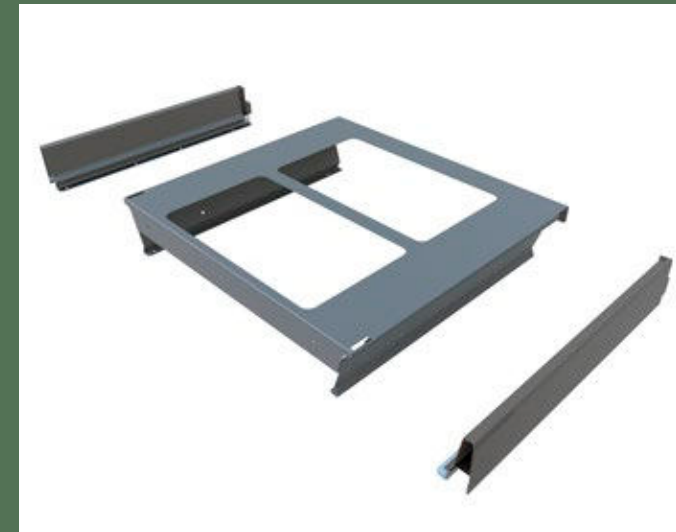

Telaio in versione BLUM® Tandembox intivo / antaro (cassetto - M)  
 Frame BLUM® Tandembox intivo / antaro Version (M drawer)  
 Bastidor en versión BLUM® Tandembox intivo / antaro (cajón - M)



Telaio in versione BLUM® Legrabox (cassetto - C)  
 Frame BLUM® Legrabox Version (C drawer)  
 Bastidor en versión BLUM® Legrabox (cajón - C)

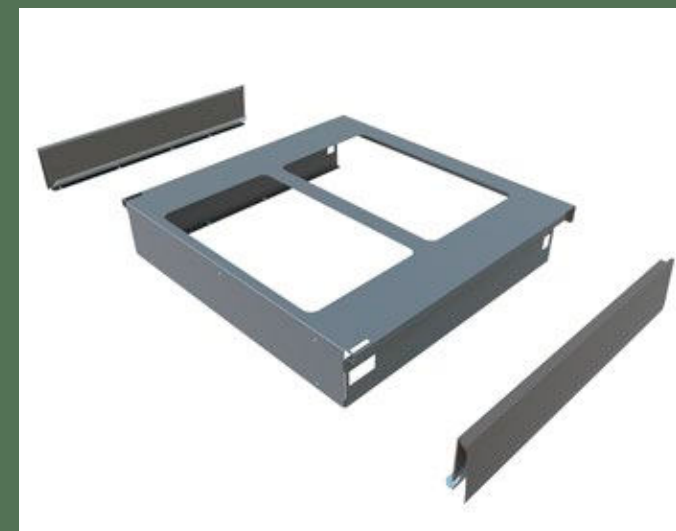

Telaio in versione BLUM® Merivobox (cassetto - M)  
 Frame BLUM® Merivobox Version (M drawer)  
 Bastidor en versión BLUM® Merivobox (cajón - M)

Su richiesta è possibile realizzare il telaio anche per HETTICH e GRASS  
 On request, the frame can also be made for HETTICH and GRASS  
 Bajo pedido, el marco también se puede hacer para HETTICH y GRASS

BLUM® TANDEMBOX INTIVO/ANTARO

PA3 INC5045A

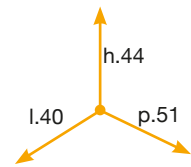

24 8 8

C97

kg A 1,7 B 2,3

Av

1+1 A+B

A 12X51X42 B 55X24X34

B 40 A 80

A 84X120X220 B 80X120X235

45

PA3 INC5045B

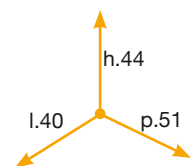

24 24

C97

kg A 1,7 B 2,2

Av

1+1 A+B

A 12X51X42 B 55X24X34

B 40 A 80

A 84X120X220 B 80X120X235

45

PA3 INC5060A

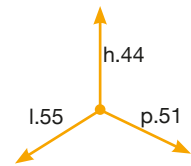

24 24 8 8

C97

kg A 2 B 3

Av

1+1 A+B

A 12X51X57 B 55X24X34

B 40 A 80

A 84X120X243 B 80X120X235

60

PA3 INC5060F

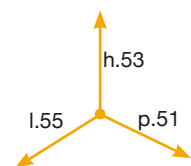

35 35

C97

kg A 2 B 2,4

Av+P

1+1 A+B

A 56X15X49 B 28X38X60

B 48 A 32

A 84X120X220 B 80X120X235

60

PA3 AE--



PA3 AE45  
PA3 AE60



kg A 1,7 (45) B 1,8 (60)

Av

1

A 8X39X49 B 8X54X49

45/60

BLUM® LEGRABOX

PA3 LEC5045A



24 8 8

C97

kg A 1,7 B 2

Av

1+1 A+B

A 20X51X42 B 55X24X34

B 40 A 48

A 80X120X235 B 84X120X220

45

PA3 LEC5045B



24 24

C97

kg A 1,7 B 2,2

Av

1+1 A+B

A 20X51X42 B 55X24X34

B 40 A 48

A 80X120X235 B 84X120X220

45

PA3 LEC5060A

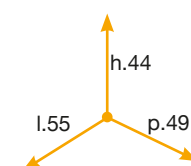

24 24 8 8

C97

kg A 2,6 B 3

Av

1+1 A+B

A 20X51X57 B 55X24X34

B 32 A 40

A 80X120X235 B 84X120X220

60

PA3 LEC5060F

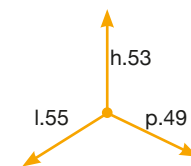

35 35

C97

A 2 B 2,9

Av

1+1 A+B

A 12X51X57 B 40X23X60

B 40 A 80

A 84X120X220 B 80X120X235

60

PA3 AE--



PA3 AE45  
PA3 AE60

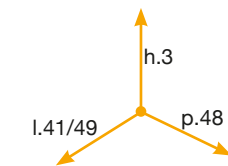

kg A 1,7 (45) B 1,8 (60)

Av

1

A 8X39X49 B 8X54X49

45/60



BLUM® MERIVOBX



A 2,2  
B 1,8

Av

1+1 A+B

A 20X51X42  
B 56X24X34

B 56  
A 40

A 80X120X220  
B 84X120X235

45

24 24

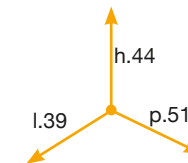

PA3 MER5045A



A 2,6  
B 2,9

Av

1+1 A+B

A 20X51X57  
B 50X24X34

B 36  
A 40

A 80X120X220  
B 84X120X235

60

24 24 8 8

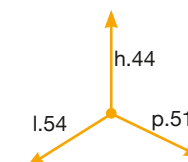

PA3 MER5060A



A 2  
B 2,9

Av

1+1 A+B

A 12X51X57  
B 40X23X60

B 40  
A 80

A 84X120X220  
B 80X120X235

60

35 35



PA3 MER5060F

A 1,7 (45)  
B 1,8 (60)

Av

1

A 8X39X49  
B 8X54X49

45/60

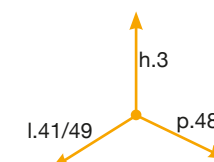

PA3 AE45  
PA3 AE60



PA3 AE--

# Block 2.0

Linea di pattumiere di Grande e Grandissima capacità per raccolta differenziata.

Sistema completo ed estremamente robusto realizzato con componenti in lamiera di acciaio zincato verniciato a polveri epossidiche e plastiche in Nylon caricato in fibra di vetro, viene fornito con guide Hettich ad estrazione totale con soft-closing. Il sistema ottimizza al massimo lo spazio disponibile sia per soluzioni di grandissima capacità in basi della cucina dedicate, sia in soluzioni in profondità ridotta idoneo anche per esser inserito in basi con lavello. Progettato per un'installazione semplice e veloce, ha un sistema di regolazione dell'anta in 3D pratico che garantisce la massima precisione. La sede di alloggiamento dei contenitori è caratterizzata da un profilo imbutito che oltre ad irrobustire la struttura la rende anche più gradevole. Il ripiano in metallo è un optional utile come coperchio fisso o ripiano porta oggetti. Disponibile per basi di larghezza 300mm, 400mm, 450mm, 500mm e 600mm ed in profondità 350mm, 420mm e 470mm; sia nelle versione da collegare direttamente all'anta, sia con maniglia per un'apertura manuale.

## Caratteristiche:

1. Struttura in lamiera di acciaio zincato verniciato a polveri epossidiche realizzata in un monoblocco.
2. Fissaggio laterale e frontale in Nylon caricato con fibra di vetro dotato di guide Hettich V6 ad estrazione totale e soft closing.
3. Alloggi dei contenitori realizzati con profilo imbutito.
4. Contenitori da 12 a 35 litri (capacità complessiva fino a 86 litri).
5. Disponibile in 5 larghezze e 3 profondità.
6. Compatibile con fianchi da 16, 18 e 19 mm.
7. Può esser collegata direttamente all'anta oppure montato all'interno di una base con anta incernierata.
8. L'optional svolge la funzione di ripiano porta oggetti o coperchio fisso.
9. Facile da installare e da pulire.
10. Regolazione in 3D dell'anta. Regolazione in 3D dell'anta.

Large and Very Large Capacity bins range for separate waste collection. Extremely solid structure made out of components in Epoxy powder painted galvanized steel and Fiberglass connectors equipped with Hettich full extension soft-closing runners. The system maximizes the available space both for very large capacity solutions in standard kitchen bases and in lower depth cabinets. Block 2.0 is also suitable for under sink bases. Designed for quick and easy installation, it has a practical 3D door adjustment system that guarantees maximum precision. The housing space for the bins is characterized by a deep-drawn profile that strengthens the structure and makes it more attractive. The metal shelf ( optional ) can be used as a fixed lid or eventually as a simple rack for any object. Available for base widths of 300mm, 400mm, 450mm, 500mm and 600mm and depth 350mm, 420mm and 470mm; in the front door fixing version or for hinged doors cabinets with manual extraction.

## Features:

1. Single block structure manufactured in Epoxy powder painted steel sheet.
2. Fiberglass reinforced Nylon supports equipped with Hettich V6 total extraction and soft closing runners.
3. Deep-drawn profile for containers housing.
4. Bins from 12 to 35 to 86 liters (total capacity up to 86 liters).
5. Available in 5 widths and 3 depths.
6. Compatible to 16, 18 and 19 mm panel thickness.
7. To be fixed directly to the front door or installed inside a cabinet base with hinged door.
8. The accessory acts as a shelf for objects or as a fixed cover.
9. Easy assembling and cleaning.
10. 3D adjustment of the door.

Línea de contenedores de grande y muy grande capacidad para la recogida selectiva de residuos.

Sistema completo y extremadamente robusto hecho de componentes de chapa de acero galvanizado recubierto de polvo epoxídico y plástico de nylon reforzado con fibra de vidrio, suministrado con guías con extracción total y amortiguación integrada de Hettich. El sistema optimiza al máximo el espacio disponible, tanto para soluciones de gran capacidad en armarios de cocina específicos como en soluciones de profundidad reducida también adecuadas para su inserción en armarios con fregadero. Diseñado para una instalación rápida y fácil, tiene un práctico sistema de ajuste de la puerta en 3D que garantiza la máxima precisión. El alojamiento de los contenedores se caracteriza por un perfil canalizado que no sólo refuerza la estructura, sino que también la hace más agradable. El estante de metal es una opción útil como tapa fija o estante para objetos. Disponible para bases de 300mm, 400mm, 450mm, 500mm y 600mm de ancho y 350mm, 420mm y 470mm de profundidad; ambas en la versión para ser conectadas directamente a la puerta y con manija para apertura manual.

## Caratteristiche:

1. Estructura en chapa de acero galvanizado recubierta de polvo epoxídico, hecha en un monobloque.
2. Fijación de los lados y de la fuente en nylon reforzado de fibra de vidrio con guías de Hettich V6 con extracción total y amortiguación integrada.
3. Estructura metálica de los contenedores realizada con perfil canalizado
4. Contenedores de 12 a 35 litros (capacidad total de hasta 86 litros).
5. Disponible en 5 anchos y 3 profundidades.
6. Compatible con paneles de 16, 18 y 19 mm.
7. Puede conectarse directamente a la puerta o montarse dentro de una base con puerta abatible.
8. El extra opcional actúa como un estante para objetos o una tapa fija.
9. Fácil de instalar y limpiar.
10. Ajuste de la puerta en 3D. Ajuste de la puerta en 3D.





# Block 2.0

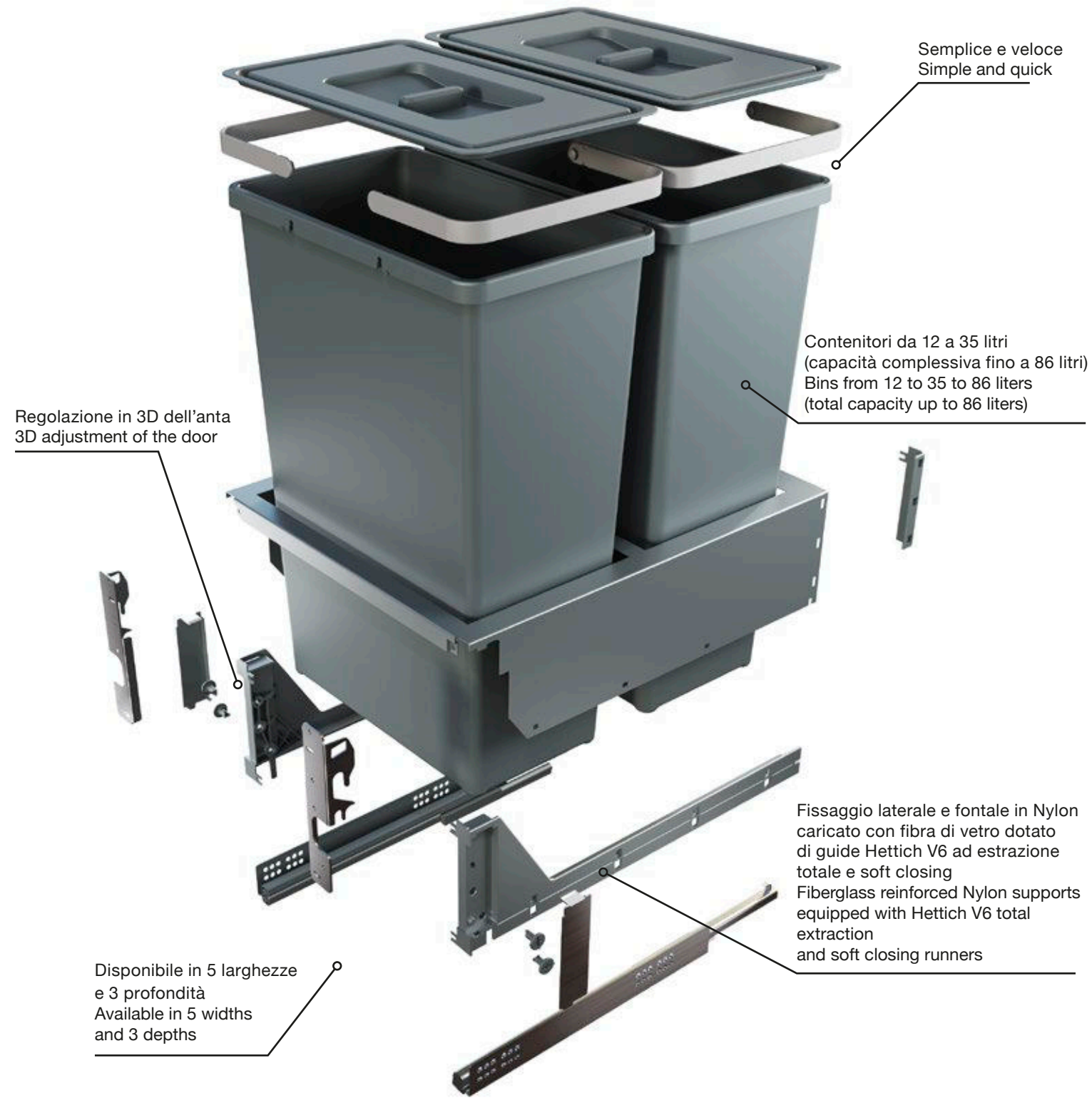

**Colore**  
Colors



**Finitura** Lamiera Verniciata  
**Finish** Varnished sheet metal

**Dimensioni**  
**Dimensions** Disponibile per tutte le larghezze e  
profondità offerte  
Available for all offered widths and  
depths

Coperchio opzionale per articoli:  
PBR A4230A  
PBR A4245A  
PBR A4250A  
PBR A4260A  
PBR A4730A  
PBR A4740A  
PBR A4745A  
PBR A4750A  
PBR A4760A



PBR A4230A

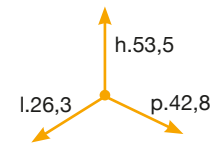

	C97		5		Av
	1		60x42x28		
	28		84x120x238		

35



PBR A4245A

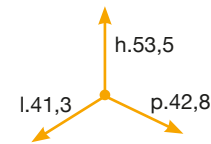

	C97		5		Av
	1		60x42x28		
	28		84x120x238		

35 12



PBR A4250A

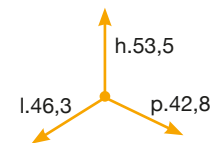

	C97		6		Av
	1		60x62x28		
	20		100X125X224		

35 12



PBR A4260A

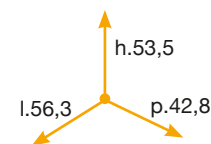

	C97		6		Av
	1		60x62x28		
	20		100X125X224		

35 35



PBR A4730A

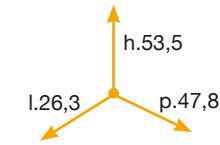

	C97		5		Av
	1		60x42x28		
	28		84X120X238		

35



PBR A4740A

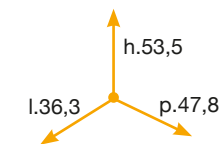

	C97		5		Av
	1		53X44X45		
	24		80X120X231		

35



PBR A4745A

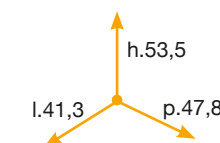

	C97		5		Av
	1		60X42X28		
	28		84X120X238		

35 35



PBR A4750A



	C97		6		Av
	1		60X62X28		
	20		100X125X224		

35 35



PBR A4760A

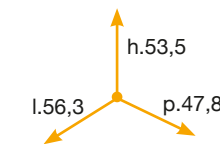

	C97		6		Av
	1		60X62X28		
	20		100X125X224		

35 35 8 8



# Block 2.0 U-Sink

Linea di pattumiere automatiche e manuali per basi lavello. Sistema completo ed estremamente robusto realizzato con componenti in lamiera di acciaio zincato verniciato a polveri epossidiche e plastiche in Nylon caricato in fibra di vetro, viene fornito con guide Hettich ad estrazione totale con soft-closing. Il sistema ottimizza al massimo lo spazio disponibile grazie alla profondità ridotta che permette la raccolta differenziata (fino a 3 contenitori) nonostante l'ingombro dei sifoni e del lavello. Progettato per un'installazione semplice e veloce; la versione Automatica ha un sistema di regolazione dell'anta in 3D pratico e robusto che garantisce la massima precisione; la versione Manuale invece permette l'inserimento del prodotto anche in basi lavello con sportello con cerniere già esistenti. La sede di alloggiamento dei contenitori è caratterizzata da un profilo imbutito che oltre ad irrobustire la struttura la rende anche più gradevole. Il ripiano in metallo è un optional utile come coperchio fisso o ripiano porta oggetti. Disponibile per basi di larghezza 500mm e 600mm.

## Caratteristiche:

1. Struttura in lamiera di acciaio zincato verniciato a polveri epossidiche realizzata in un monoblocco.
2. Fissaggio laterale e frontale in Nylon caricato con fibra di vetro dotato di guide Hettich V6 ad estrazione totale e soft closing.
3. Alloggiamenti dei contenitori realizzati con profilo imbutito.
4. Contenitori da 8 a 18 litri (capacità complessiva fino a 42 litri).
5. Disponibile in versione Automatica da collegare all'anta.
6. Disponibile in versione Manuale per basi con anta incernierata.
7. Compatibile con fianchi da 16, 18 e 19 mm.
8. Può essere collegata direttamente all'anta oppure
9. L'optional svolge la funzione di ripiano porta oggetti o coperchio fisso.
10. Facile da installare e da pulire.

Line of automatic and manual waste bins systems for sink bases. Complete and extremely robust system made out of galvanized steel sheet components painted with epoxy powders and with Nylon loaded with fiberglass, supplied with Hettich full extension runners with soft-closing. The system maximizes the available space thanks to the reduced depth that allows separate waste collection (up to 3 containers) despite of reducing encumbrance of the siphons and the sink. Designed for quick and easy installation; the Automatic version has a practical and robust 3D door adjustment system that guarantees maximum precision; the Manual version instead allows the insertion of the product also into existing door hinged sink bases. The housing structure of the containers is characterized by a deep-drawn profile which in addition strengthens the structure and also gives it a refined look. The metal shelf is an optional useful as a fixed cover or a shelf for objects. Available for 500mm and 600mm wide bases.

## Features:

1. Monobloc structure in galvanized steel sheet painted with epoxy powders.
2. Side fixing and front in Nylon fiberglass equipped with Hettich V6 full extension slides with soft closing.
3. Accommodation of containers made with drawn profile.
4. Containers from 8 to 18 liters (total capacity up to 42 liters).
5. Available in automatic version to be connected to the door.
6. Available in Manual version for bases with hinged door versions.
7. Compatible with 16, 18 and 19 mm sides.
8. Can be connected directly to the door.
9. The optional has the function of a shelf for objects or fixed cover.
10. Easy to install and clean.

Línea de contenedores con apertura automática y manual para las bases con fregaderos. Sistema completo y extremadamente robusto hecho de componentes de chapa de acero galvanizado recubierto de polvo epoxídico y plástico de nylon reforzado con fibra de vidrio, suministrado con las guías de cierre suave de extensión total de Hettich. El sistema optimiza al máximo el espacio disponible gracias a su reducida profundidad, que permite la recogida separada (hasta 3 contenedores) a despecho del tamaño de los sifones y el fregadero. Diseñado para una instalación rápida y fácil; la versión Automática tiene un práctico y robusto sistema de ajuste de la puerta en 3D que garantiza la máxima precisión; la versión Manual, en cambio, permite introducir el producto en las bases de los lavabos existentes con puerta abatible. El alojamiento de los contenedores se caracteriza por un perfil de embutición profunda que no sólo refuerza la estructura, sino que también la hace más agradable. El estante de metal es una opción útil como tapa fija o estante para objetos. Disponible para bases de 500 y 600 mm de ancho.

## Caratteristiche:

1. Estructura de chapa de acero galvanizado recubierta de polvo epoxídico hecha en un monobloque.
2. Fijación de los lados y de la fuente en Nylon relleno de fibra de vidrio equipado con guías Hettich V6 con extensión total y amortiguación integrada.
3. Estructura metálica para los contenedores realizada con perfil canalizado.
4. Contenedores de 8 a 18 litros (capacidad total de hasta 42 litros).
5. Disponible en versión automática para ser conectada a la puerta.
6. Disponible en versión manual para bases con puerta abatible.
7. Compatible con tableros de 16, 18 y 19 mm.
8. Puede conectarse directamente a la puerta o extraerse manualmente.
9. La opción actúa como un estante de objetos o una tapa fija.
10. Fácil de instalar y limpiar.



Semplicità di installazione  
e facile da pulire  
Simple installation  
and easy to clean

Contenitori in polipropilene  
completamente riciclabile  
da 12 a 18 litri  
Fully recyclable  
polypropylene containers  
from 12 to 18 litres

Tutte le pattumiere sono dotate  
di un secchio con coperchio con  
filtro divora odore (rigenerabile con  
lavaggio fino a 50 volte)  
All the kits have a bin with an  
odour-eating filter lid with an  
odour-eating filter (regenerable by  
washing up to 50 times)

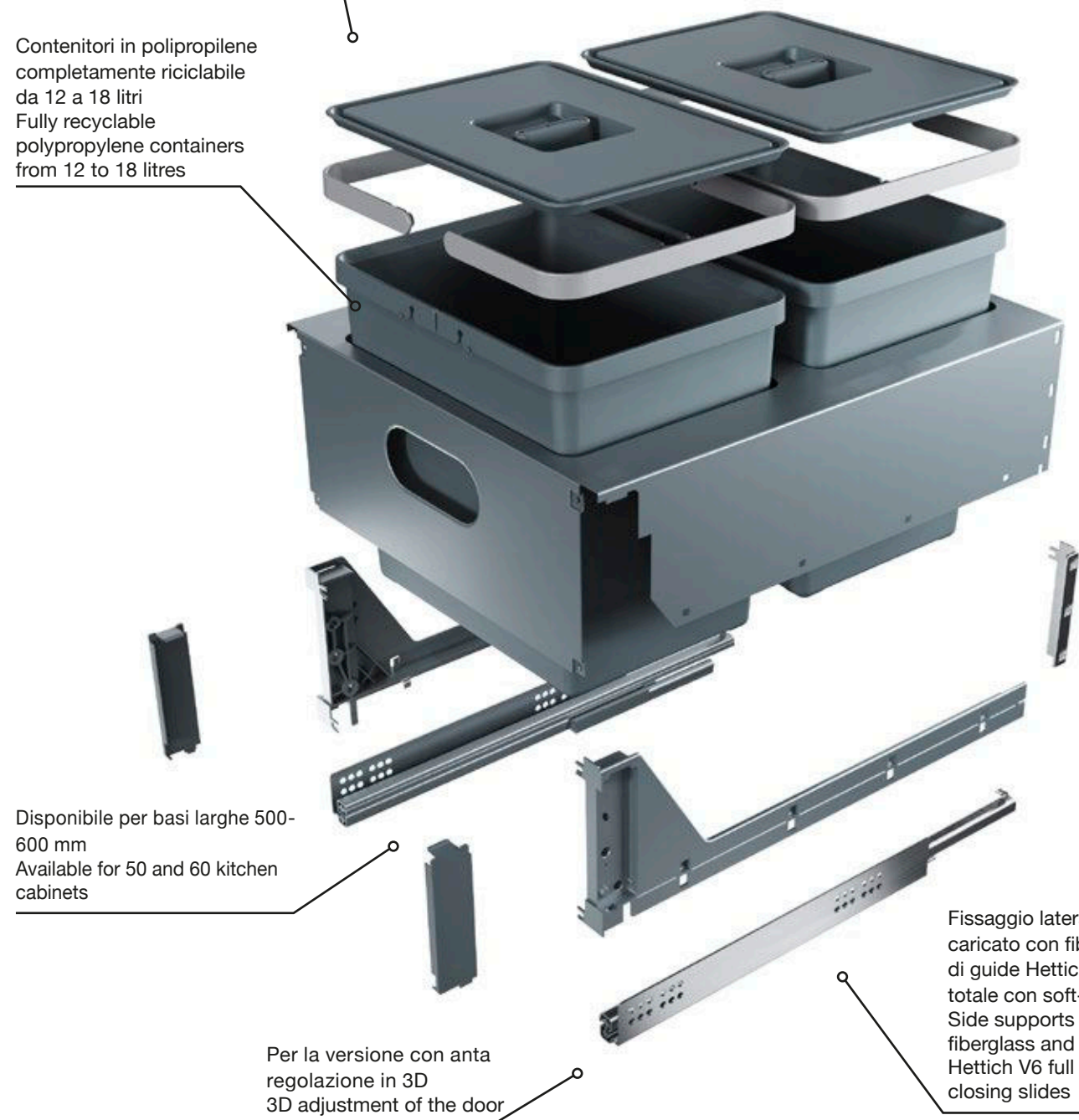

Disponibile per basi larghe 500-  
600 mm  
Available for 50 and 60 kitchen  
cabinets

Per la versione con anta  
regolazione in 3D  
3D adjustment of the door

Fissaggio laterale in Nylon  
caricato con fibra di vetro dotato  
di guide Hettich V6 ad estrazione  
totale con soft-closing  
Side supports in reinforced nylon  
fiberglass and equipped with  
Hettich V6 full extension soft  
closing slides

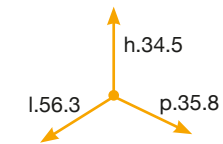
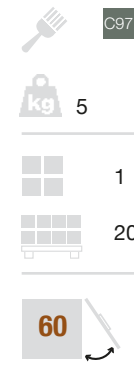

12 8 8

Apertura manual  
Manual opening



PBR B3560B

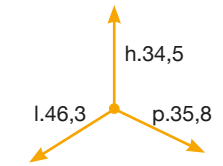
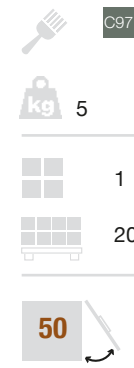

18 12

Apertura con anta  
Hinged door opened version



PBR A3550A

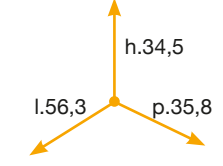
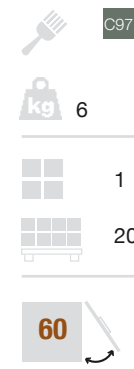

18 18

Apertura con anta  
Hinged door opened version



PBR A3560A

Colore  
Colors

Finitura  
Finish

Coperchio opzionale per articoli:  
PBR C3550  
PBR C3560

Dimensioni  
Dimensions



PBR ----

# Block 2.0 U-Top

Linea di pattumiere per la raccolta differenziata che permette di posizionare i propri contenitori al di sotto del piano della cucina facilitando così le operazioni di smaltimento dei rifiuti.

Sistema completo composto da un monoblocco in lamiera di acciaio zincato verniciato a polveri epossidiche fornito di guide Hettich V6 ad estrazione totale con soft-closing. La sede di alloggiamento dei contenitori è caratterizzata da un profilo imbutito che oltre ad irrobustire la struttura la rende anche più gradevole. Con la Block U Top 2.0, lo spazio interno del mobile, viene ottimizzato al massimo, (anche in una base da 30). La parte inferiore che rimane libera permette l'utilizzo di un ulteriore cassetto (con l'inserimento di altre pattumiere) oppure di riordinare a proprio piacimento qualsiasi oggetto casalingo. L'utilizzo di questo sistema è possibile sia con anta ad apertura frontale che con cerniere.

## Caratteristiche:

1. Struttura lamiera di acciaio zincato verniciato a polveri epossidiche realizzata in un monoblocco
2. Fissaggio laterale in Nylon caricato con fibra di vetro dotato di guide Hettich V6 ad estrazione totale con soft-closing
3. Alloggi dei contenitori realizzati con profilo imbutito
4. Disponibile per basi larghe 300 mm, 400 mm e 450 mm
5. Contenitori in polipropilene completamente riciclabile da 6 a 15 litri
6. Tutte le pattumiere sono dotate di un secchio con coperchio con filtro divora odore (rigenerabile con lavaggio fino a 50 volte)
7. Semplicità di installazione
8. Facile da pulire

Product range for separating waste allowing you to place the containers under the worktop of the kitchen which will facilitate handling of your waste.

The complete system consists out of a single galvanized steel structure, epoxy powder painted and equipped with Hettich V6 full extension soft closed sliders. The setting of the containers is characterized by a deep drawn profile which reinforces the structure and giving it a final "touch". The Block U Top 2.0 allows to optimise the internal space of the cabinet even in a base of 30. The lower part that remains free might be used with an additional drawer which eventually can contain other buckets or can be used with any other household items as you prefer. The use of this system is possible both with front door opening and with hinge door opening.

## Features:

1. Structure in a single galvanized steel frame with a epoxy powders painted finish
2. Side supports in reinforced nylon fiberglass and equipped with Hettich V6 full extension soft closing slides
3. Container housing made out of a characteristic deep-drawn profile
4. Available for 30, 40 and 45 kitchen cabinets
5. Fully recyclable polypropylene containers from 6 to 15 litres
6. All the kits have a bin with an odour-eating filter (regenerable by washing up to 50 times)
7. Simple installation
8. Easy to clean

Línea de contenedores para la recogida selectiva de residuos que permite colocar los contenedores debajo de la encimera de la cocina, facilitando así las operaciones de eliminación de residuos.

Sistema completo que consiste en un monobloque de chapa de acero galvanizado revestido de polvo epoxídico equipado con guías de cierre suave de extensión total Hettich V6. La carcasa del contenedor se caracteriza por un perfil canalizado que no sólo refuerza la estructura, sino que también la hace más atractiva. Con el Block U Top 2.0, el espacio interno del gabinete se optimiza al máximo (incluso en una base de 30"). La parte inferior que queda libre permite utilizar un cajón adicional (con la inserción de otros contenedores) o para ordenar cualquier artículo del hogar a voluntad. El uso de este sistema es posible tanto con puertas de apertura frontal como con bisagras.

## Caratteristiche:

1. Estructura de chapa de acero galvanizado con recubrimiento de polvo epoxídico hecha de un monobloque
2. Fijación lateral de nylon reforzado con fibra de vidrio con guías de cierre suave de extensión total Hettich V6
3. Estructura metálica para los contenedores realizada con perfil canalizado
4. Disponible para bases de 300 mm, 400 mm y 450 mm de ancho
5. Contenedores de polipropileno totalmente reciclables de 6 a 15 litros
6. Todos los cubos de basura están equipados con un cubo con tapa con filtro de olores (puede ser regenerado hasta 50 veces).
7. Facilidad de instalación
8. Fácil de limpiar



Semplicità di installazione  
e facile da pulire  
Simple installation  
and easy to clean

Contenitori in polipropilene  
completamente riciclabile  
da 12 a 18 litri  
Fully recyclable  
polypropylene containers  
from 12 to 18 litres

Disponibile per basi larghe 300-  
450 mm  
Available for 30, 40 and 45 kitchen  
cabinets

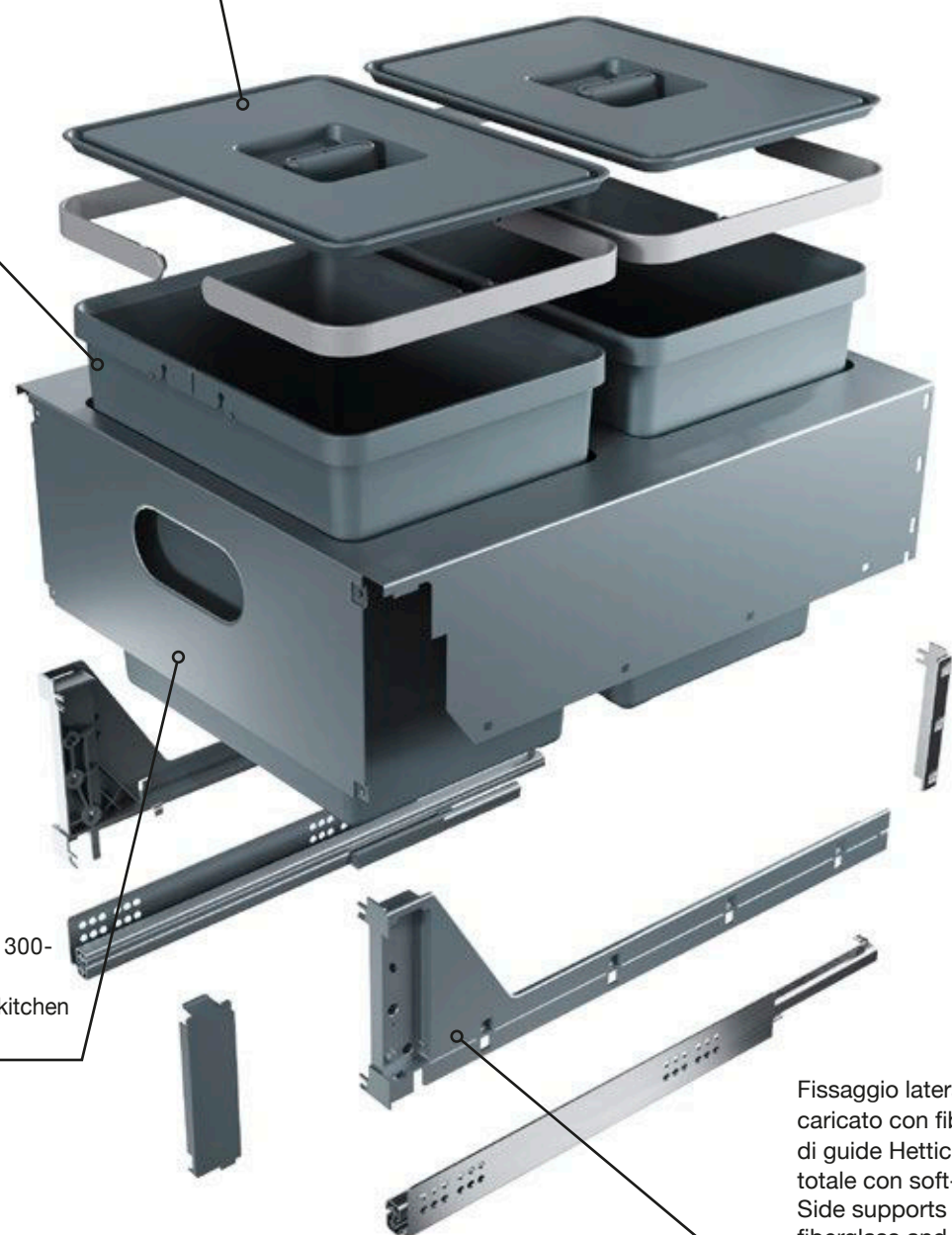

Fissaggio laterale in Nylon  
caricato con fibra di vetro dotato  
di guide Hettich V6 ad estrazione  
totale con soft-closing  
Side supports in reinforced nylon  
fiberglass and equipped with  
Hettich V6 full extension soft  
closing slides

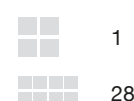
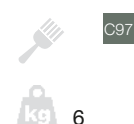
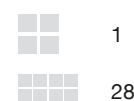
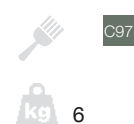
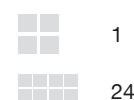
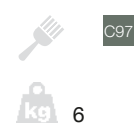
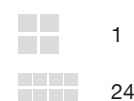
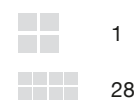
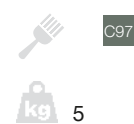

AV

60X42X28

84X120X238

AV

53X44X45

80X120X231

AV

53X44X45

80X120X231

AV

60X4X28

84X120X238

AV

60X42X28

84X120X238

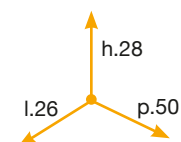

10 10

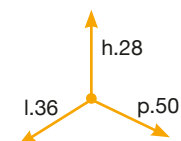

15 15

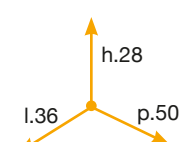

15 6 6

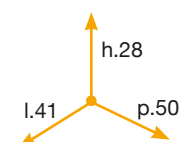

15 15

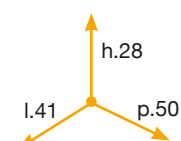

15 6 6

Apertura manual  
Manual opening



PBR B4730A

Apertura manual  
Manual opening



PBR B4740A

Apertura manual  
Manual opening



PBR B4740B

Apertura manual  
Manual opening



PBR B4745A

Apertura manual  
Manual opening



PBR B4745B

# Free Form

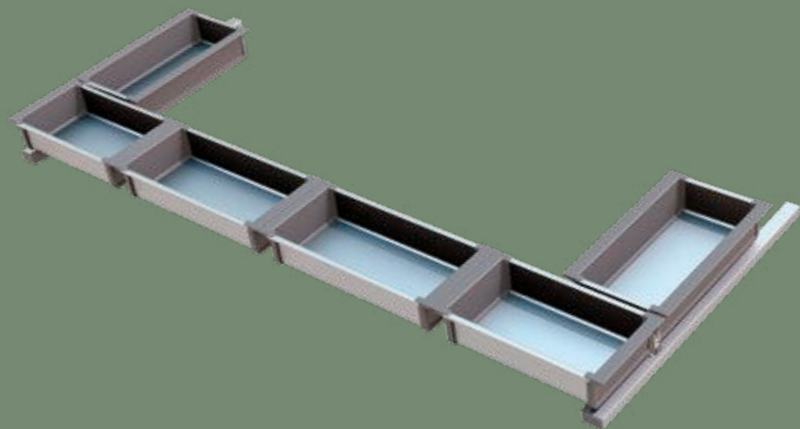

La soluzione ideale per organizzare lo spazio nel cassetto alto del sotto-lavello.

Ha un design minimale ed elegante e può essere personalizzato nelle finiture (alluminio o lamiera verniciata o acciaio inox; plastiche colorate).

## Caratteristiche:

1. Caratterizzato da una struttura BREVETTATO in Alu Plast.
2. La struttura si integra completamente con le sponde (16mm) del cassetto.
3. Viene fornito completo di vaschette in alluminio plastica, posizionabili secondo le esigenze.
4. Disponibile per tutte le più comuni marche di cassetti. Nasce come standard per tutte le tipologie di guide per cassetti (Blum; Grass; Hettich; FGV; ...)
5. Facile da pulire.
6. Ha un design minimale ed elegante e può essere personalizzato nelle finiture (alluminio o lamiera verniciata o acciaio inox; plastiche colorate).
7. È disponibile in tutte le misure (non solo 60, 90 e 120; ma anche 50, 80, 100, ...).
8. Può essere fornito smontato (si assembla in pochi minuti) comportando importanti risparmi logistici.
9. Può essere velocemente ritrafilato (per portarlo a dimensioni speciali per basi "fuori misura").

The ideal solution to organize the space in the top of the under-sink drawer.

It has a minimalist design and elegant and can be customized finishes (aluminum or painted steel or stainless steel, colored plastics).

## Features:

1. Featuring a PATENTED structure in Alu Plast.
2. The structure integrates fully in the appropriate space (16mm) of the drawer.
3. Comes complete with plastic aluminium trays can be positioned as needed.
4. Available for all popular brands of drawers. Comes as standard for all types of drawer slides (Blum, Grass, Hettich, FGV, ...).
5. Easy to clean.
6. It has a minimalist design and elegant and can be customized finishes (aluminium or steel painted or stainless steel, colored plastics).
7. Available in all sizes (not just 60, 90 and 120, but also 50, 80, 100, ...).
8. Can be supplied separate (assembles in minutes) resulting in significant savings in logistics.
9. Can be quickly redrawn (to bring in special sizes to basics "oversized") cut.

La solución ideal para organizar el espacio en la parte superior del cajón bajo fregadero.

Tiene un diseño minimalista y elegante y se puede personalizar acabados (aluminio o acero pintado o acero inoxidable, plásticos de colores).

## Características:

1. Con una estructura patentada en Alu Plast.
2. La propiedad está totalmente integrado con los bancos (16 mm) del cajón.
3. Viene completo con bandejas de aluminio de plástico se puede colocar como sea necesario.
4. Disponible para todas las marcas populares de cajones. Viene de serie para todos los tipos de diapositivas del cajón (Blum, Grass, Hettich, FGV, ...).
5. Fácil de limpiar.
6. Tiene un diseño minimalista y elegante y se puede personalizar acabados (aluminio o acero, acero pintado o inoxidable, plásticos de colores).
7. Disponible en todos los tamaños (no sólo 60, 90 y 120, pero también 50, 80, 100, ...).
8. Puede ser suministrado por separado (se ensambla en minutos) que resulta en un ahorro significativo en la logística.
9. Puede ser rápidamente vuelve a dibujar (para llevar en tamaños especiales a lo básico "de gran tamaño") cortado.



Caratterizzato da una struttura BREVETTATA in Alu Plast  
*Featuring a PATENTED structure in Alu Plast*  
 Con una estructura patentada en Alu Plast

Può essere fornito smontato (si assembla in pochi minuti) comportando importanti risparmi logistici  
*Can be supplied separate (assembles in minutes) resulting in significant savings in logistics*  
 Puede ser suministrado por separado (se ensambla en minutos) que resulta en un ahorro significativo en la logística

Viene fornito completo di vaschette in alluminio plastica, posizionabili secondo le esigenze  
*Comes complete with plastic aluminium trays can be positioned as needed*  
 Viene completo con bandejas de aluminio de plástico se puede colocar como sea necesario

Ha un design minimale ed elegante e può essere personalizzato nelle finiture (alluminio o lamiera verniciata o acciaio inox; plastiche colorate)  
*It has a minimalist design and elegant and can be customized finishes (aluminium or steel painted or stainless steel, colored plastics)*  
 Tiene un diseño minimalista y elegante y se puede personalizar acabados (aluminio o acero, acero pintado o inoxidable, plásticos de colores)

Disponibile per tutte le più comuni marche di cassetti  
*Available for all popular brands of drawers*  
 Disponible para todas las marcas populares de cajones

Può essere velocemente ritrafilato (per portarlo a dimensioni speciali per basi "fuori misura")  
*Can be quickly redrawn (to bring in special sizes to basics "oversized") cut*  
 Puede ser rápidamente vuelve a dibujar (para llevar en tamaños especiales a lo básico "de gran tamaño") cortado

La struttura si integra completamente con le sponde (16mm) del cassetto  
*The structure integrates fully in the appropriate space (16mm) of the drawer*  
 La propiedad está totalmente integrado con los bancos (16 mm) del cajón

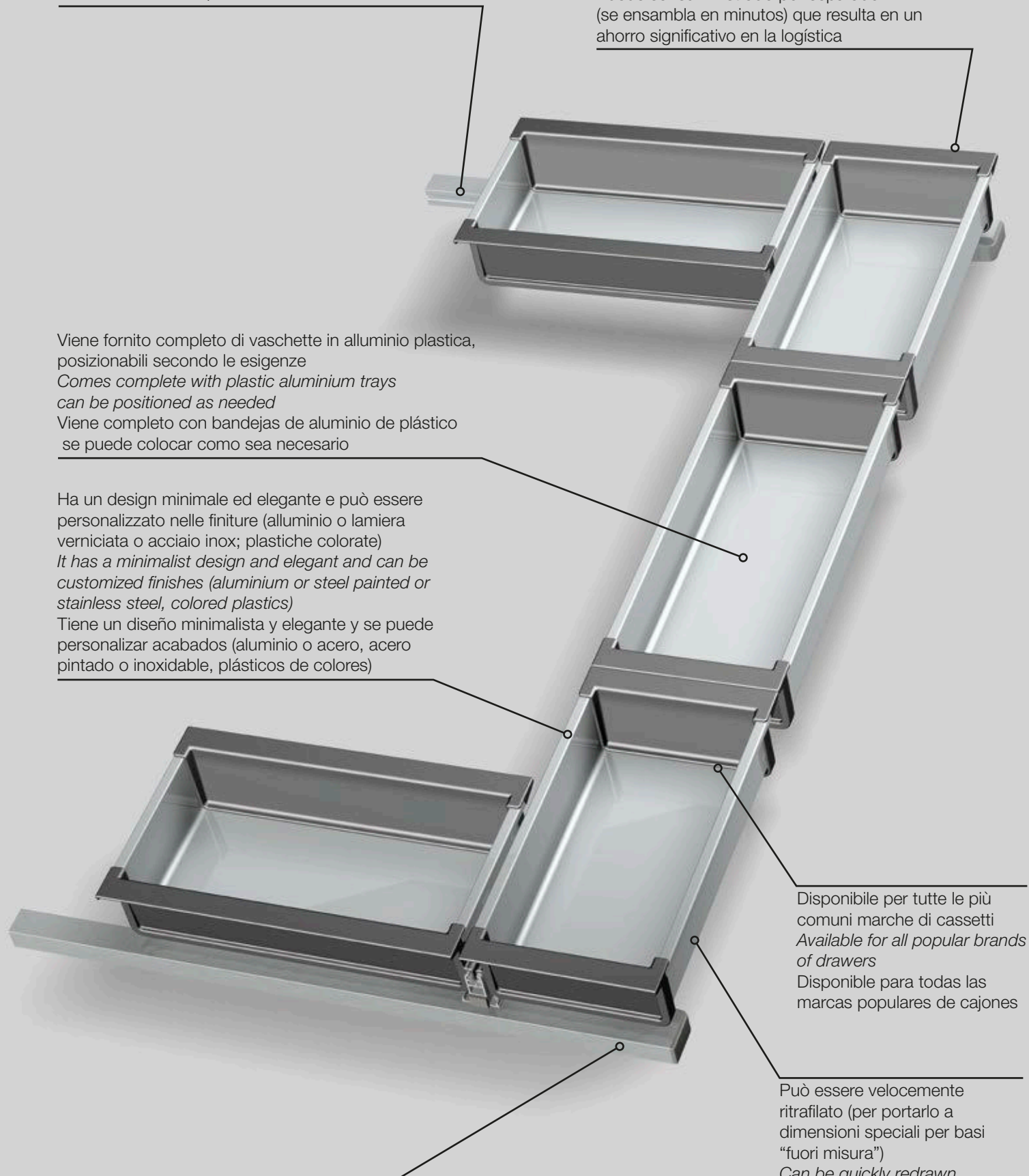

# Free Form



Vaschette in alluminio plastica, posizionabili  
*With plastic aluminium trays can be positioned as needed*  
 Con bandejas de aluminio de plástico se puede colocar como sea necesario

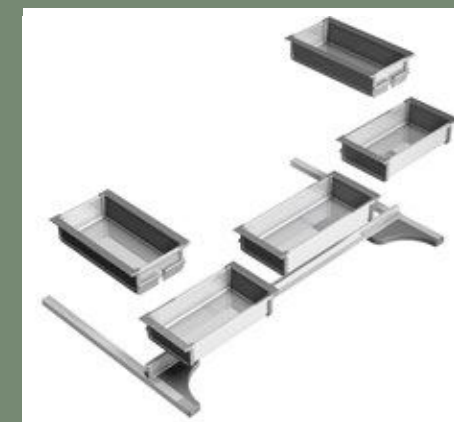

Può essere fornito smontato (si assembla in pochi minuti) comportando importanti risparmi logistici  
*Can be supplied separate (assembles in minutes) resulting in significant savings in logistics*  
 Puede ser suministrado por separado (se ensambla en minutos) que resulta en un ahorro significativo en la logística

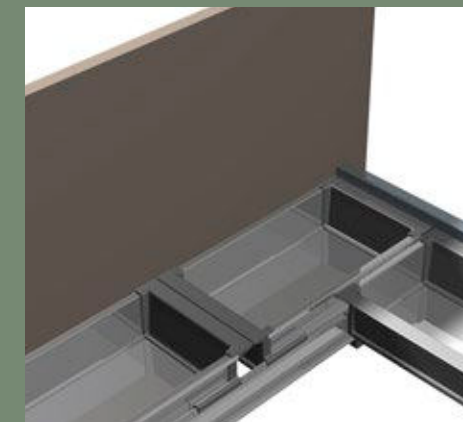

Caratterizzato da una struttura BREVETTATA in Alu Plast  
*Featuring a PATENTED structure in Alu Plast*  
 Con una estructura patentada en Alu Plast



Nasce come standard per tutte le tipologie di guide per cassetti (Blum®; Grass®; Hettich®; FGV®;...)  
*Comes as standard for all types of drawer slides (Blum®; Grass®; Hettich®; FGV®;...)*  
 Viene de serie para todos los tipos de diapositivas del cajón (Blum®; Grass®; Hettich®; FGV®;...)



Può essere velocemente ritrafilato (per portarlo a dimensioni speciali per basi "fuori misura")  
*Can be quickly redrawn (to bring in special sizes to basics "oversized") cut*  
 Puede ser rápidamente vuelve a dibujar (para llevar en tamaños especiales a lo básico "de gran tamaño") cortado

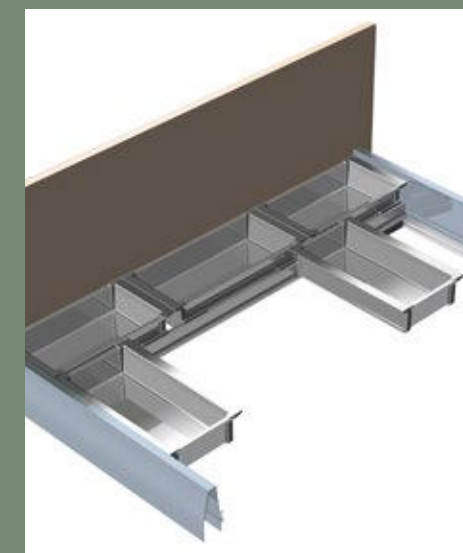

Viene fornito completo di vaschette in alluminio plastica, posizionabili secondo le esigenze  
*Comes complete with plastic aluminium trays can be positioned as needed*  
 Viene completo con bandejas de aluminio de plástico se puede colocar como sea necesario



PBL C1A 06M18 BC10

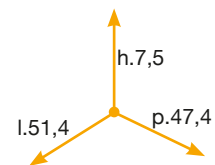

	C97		
	1,4 kg		AL
	1		53 X 17 X 21
	96		80 X 120 X 220
	60		

PBL C1A 08M18 BC10

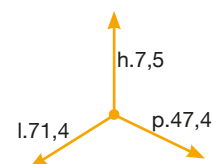

	C97		
	1,6 kg		AL
	1		73 X 17 X 21
	72		80 X 120 X 220
	80		

PBL C1A 09M18 BC10

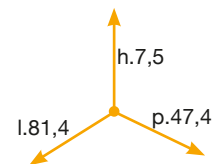

	C97		
	1,7 kg		AL
	1		83 X 17 X 21
	72		80 X 120 X 220
	90		

PBL C1A 10M18 BC10



	C97		
	1,8 kg		AL
	1		93 X 17 X 21
	48		80 X 120 X 220
	100		

PBL C1A 12M18 BC10

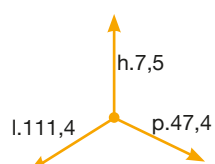

	C97		
	1,9 kg		AL
	1		113 X 17 X 21
	48		80 X 120 X 220
	120		

PBL C1A 06M18 AC10

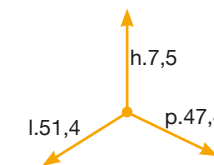

	C97		
	1,6 kg		AL
	1		53 X 17 X 21
	96		84 X 120 X 220
	60		

PBL C1A 08M18 AC10



	C97		
	1,8 kg		AL
	1		73 X 17 X 21
	72		80 X 120 X 220
	80		

PBL C1A 09M18 AC10

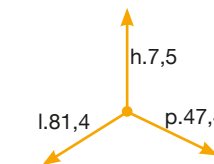

	C97		
	2 kg		AL
	1		83 X 17 X 21
	72		80 X 120 X 220
	90		

PBL C1A 10M18 AC10

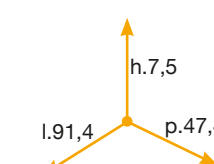

	C97		
	2,1 kg		AL
	1		93 X 17 X 21
	48		80 X 120 X 220
	100		

PBL C1A 12M18 AC10



	C97		
	2,2 kg		AL
	1		113 X 17 X 21
	48		80 X 120 X 220
	120		

# Metropolis



Unico nel suo genere il Sistema di pattumiere Metropolis è un accessorio da inserire direttamente nei cassettoni.

Un sistema flessibile che si adatta alle svariate misure interne dei cassettoni, completamente modulabile e dal montaggio estremamente semplice.

#### Caratteristiche:

1. Disponibile in 2 altezze e 3 larghezze.
2. Fornito con guarnizione flessibile per compensare le eventuali differenze di misura bloccando perfettamente il vassoio.
3. Il modello in plastica è dotato di più vasche componibili, fornite in kit di montaggio, con una notevole riduzione di ingombro dell'imballo.
4. La possibilità di spostare i divisori garantisce estrema flessibilità.
5. È possibile l'aggiunta di accessori in filo d'acciaio cromato (porta detersivo, porta vaschette, porta carta).
6. Tutte le pattumiere sono dotate di un secchio con coperchio con filtro anti-odore (rigenerabile con lavaggio fino a 50 volte).

The unique Metropolis dustbins system is an accessory that fits directly into drawers.

A flexible system that adapts to various internal sizes of drawers, completely modular and extremely easy to assemble.

#### Features:

1. Available in 2 heights and 3 widths.
2. Supplied with a flexible seal to compensate for any differences in terms of size, fully blocking the tray.
3. The plastic model has a number of modular trays, supplied in kit form, with a significant reduction in the overall size of the packaging.
4. The dividers can be repositioned to ensure flexibility.
5. Accessories in chromed steel wire can be added. (detergents holder, trays holder, paper holder).
6. All the bins have with a bucket with a lid which has an odour filter (which can be regenerated by washing for up to 50 times).

Único en su género, el Sistema de cubos de basura Metropolis es un accesorio para introducir directamente en los distribuidores.

Un sistema flexible que se adapta a las variadas medidas internas de los distribuidores, completamente modulable y con un montaje extremadamente simple.

#### Características:

1. Disponible en 2 alturas y 3 anchos.
2. Se entrega con junta flexible para compensar las posibles diferencias de medida bloqueando perfectamente la bandeja.
3. El modelo de plástico cuenta con varias cubetas auxiliares, entregadas en kit de montaje, con una notable reducción de espacio en el embalaje.
4. La posibilidad de mover los compartimentos garantiza una extrema flexibilidad.
5. Se pueden añadir accesorios de alambre de acero cromado (porta-detergente, porta-cubetas, porta-papel).
6. Todos los cubos de basura llevan un cubo con tapa y filtro anti-olor (regenerable con lavado hasta 50 veces).



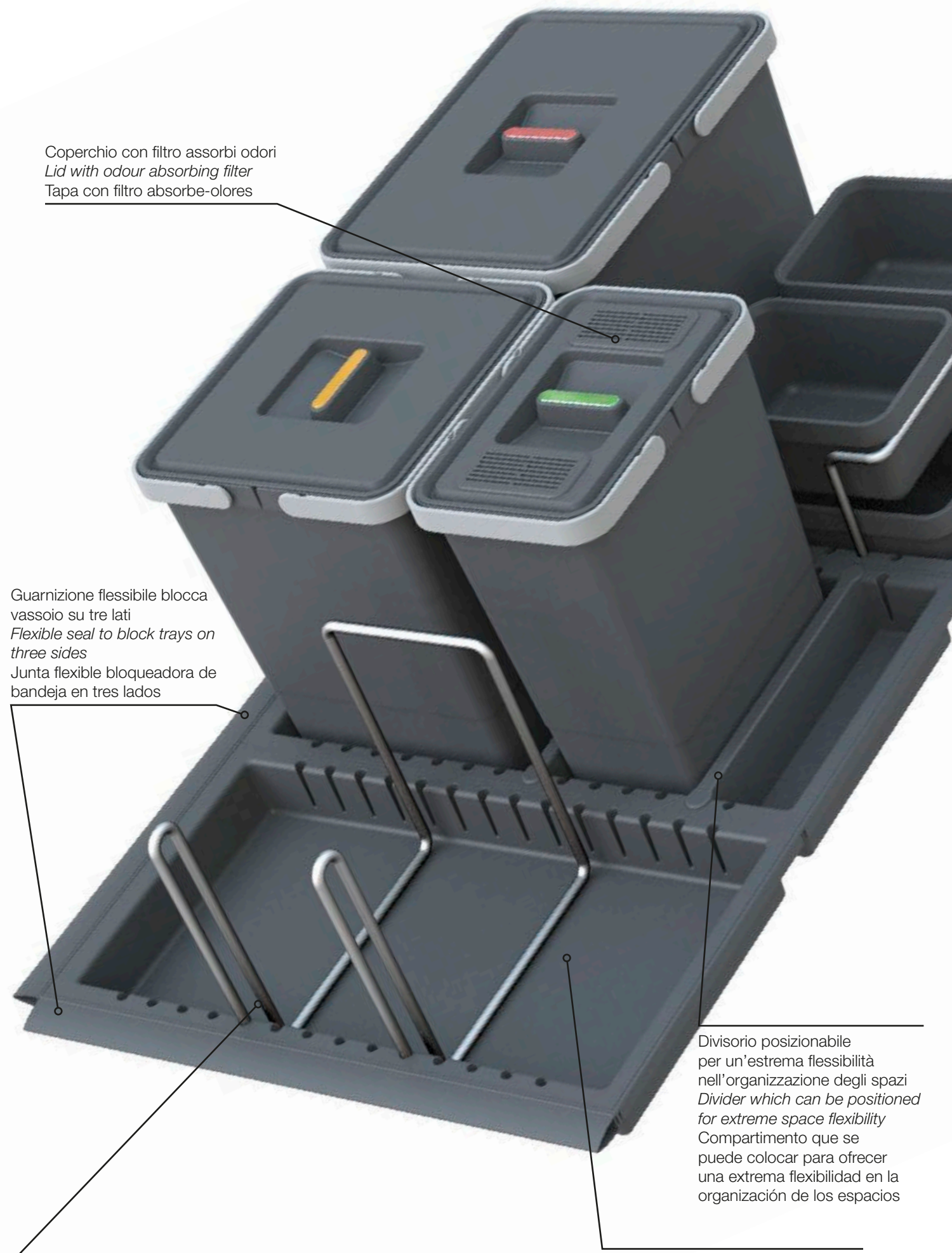

Coperchio con filtro assorbi odori  
Lid with odour absorbing filter  
Tapa con filtro absorbe-olores

Guarnizione flessibile blocca vassoio su tre lati  
Flexible seal to block trays on three sides  
Junta flexible bloqueadora de bandeja en tres lados

Divisorio posizionabile per un'estrema flessibilità nell'organizzazione degli spazi  
Divider which can be positioned for extreme space flexibility  
Compartimento que se puede colocar para ofrecer una extrema flexibilidad en la organización de los espacios

Disponibili accessori porta riviste, porta detersivi e porta vaschette  
Availability of accessories such as magazines holders, detergents holder and trays holder  
Disponibles accesorios porta-revistas, porta-detergentes y porta-cubetas

Vasche collegabili fornite in kit  
The kit includes attachable trays  
Cubetas encajables entregadas en kit

# Metropolis

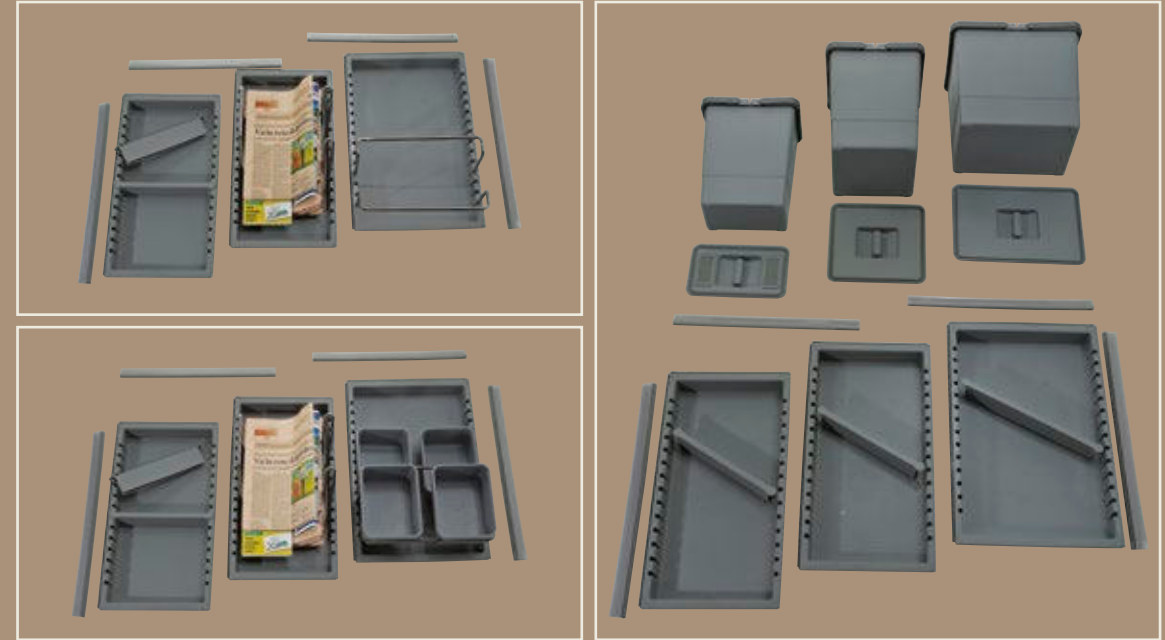

Accessorio porta-riviste  
Magazines holder accessory  
Accesorio porta-revistas



Accessorio porta-vaschette  
Tray holder accessory  
Accesorio porta-cubetas



Fornito in "kit compatto" salva-spazio  
Supplied in a compact space-saving "kit"  
Entregado en "kit compacto" para ahorrar espacio



**PTC KIT PC**  
Porta riviste  
Newspapers kit  
Puerta periódicos



**PTC KIT PD**  
Porta detersivi  
Detergents kit  
Puerta detergentes



**PTC KIT PV**  
Set vaschette  
Tray kit  
Kit de bandejas



**STA PTV 1712**  
Vaschetta  
Tray  
Tazón

PTC22 05050 7F

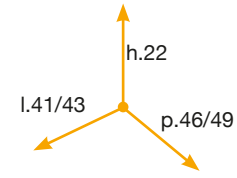

C97

kg 2,7 P

1 47X25X33

30 80X120X215

50

**12**

PTC22 06050 1F

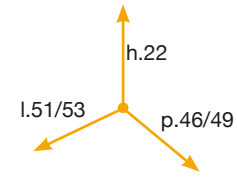

C97

kg 2,7 P

1 47X25X33

30 80X120X215

60

**12 12**

PTC22 08050 7F

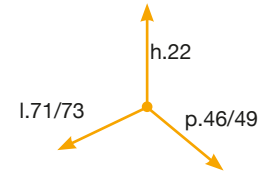

C97

kg 3,8 P

1 47X31X35

30 80X120X215

80

**12 12 12**

PTC22 09050 2F



C97

kg 4,5 P

1 47X31X35

30 80X120X225

90

**12 12 12 12**

PTC22 10050 7F

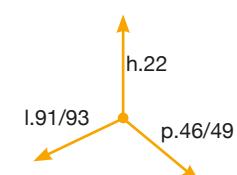

C97

kg 3,9 P

1 47X31X35

30 80X120X225

100

**12 12 12**

C97

kg 5 P

1 47X31X43

25 80X120X230

120

**12 12 12 12**

C97

kg 3,1 P

1 47X25X33

30 80X120X215

50

**10 10**

C97

kg 3,1 P

1 47X25X33

30 80X120X215

60

**15 10 10 6**

C97

kg 2,9 P

1 47X25X33

30 80X120X215

60

**15 15**

C97

kg 3,1 P

1 47X25X33

30 80X120X215

60

**15 6 6**

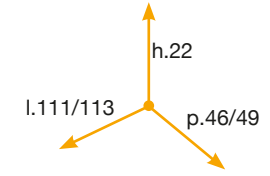

**12 12 12 12**

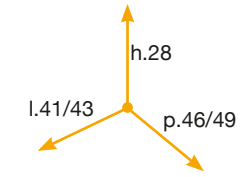

**10 10**

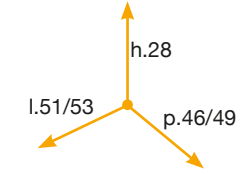

**15 10 10 6**

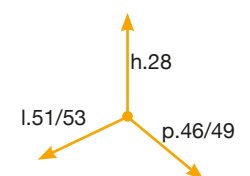

**15 15**

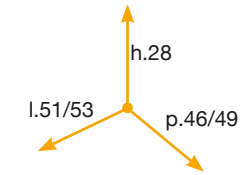

**15 6 6**

PTC22 12050 1F



PTC28 05050 7F



PTC28 06050 2F



PTC28 06050 3F



PTC28 06050 4F



PTC28 08050 7F

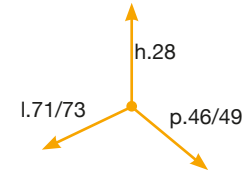

15 15 15

C97

4,1

1 47X31X35

30 80X120X225

80

PTC28 09050 9F

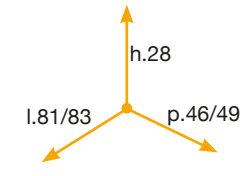

15 15 15 15

C97

5

1 47X31X35

30 80X120X225

90

PTC28 09050 2F

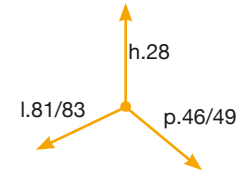

15 10 10 6

C97

4,2

1 47X31X35

30 80X120X225

90

PTC28 10050 7F

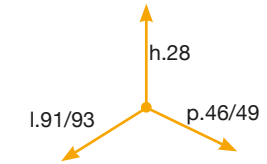

15 15 15

C97

5,1

1 47X31X43

25 80X120X230

100

PTC28 09050 3F

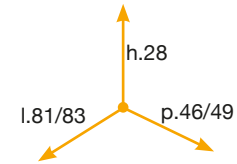

15 10 6

C97

1,7

1 47X31X35

30 80X120X225

90

PTC28 12050 4F

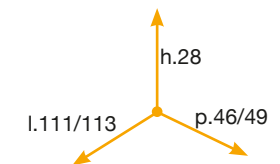

15 10 10 6

C97

4,7

1 47X31X43

25 80X120X230

120

PTC28 09050 5F

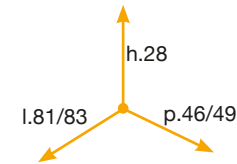

15 15 15

C97

4,2

1 47X31X35

30 80X120X225

90

PTC28 12050 1F

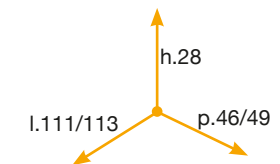

15 15 15 15

C97

5,4

1 47X31X43

25 80X120X230

120

PTC28 09050 7F

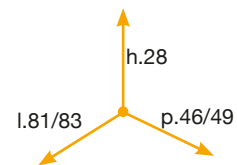

15 15 6 6

C97

4,3

1 47X31X35

30 80X120X225

90

# Compo Evo



Linea di pattumiere dedicate alla raccolta differenziata per i cassettoni sottolavello. Il sistema è composto da un monoblocco in metallo verniciato a polveri epossidiche nei quali alloggiare i contenitori. La carenatura mostra soltanto i coperchi e rende così il prodotto più essenziale e minimale. La sede di alloggiamento dei contenitori è caratterizzata da un profilo imbutito che oltre ad irrobustire la struttura la rende anche più gradevole.

Product line of waste separation for under-sink drawers. The system is composed out of two single structures of galvanized steel and epoxy powder painted in which the bins are housed. The housing only shows the top of the bin and makes it the most essential and minimalist product. The seat of location of the bins is characterized by a deep-drawn profile which strengthens the structure and gives it a clean look.

Línea de cubos de basura específicos para recogida selectiva para los cajones bajo el fregadero. El sistema está compuesto por una única pieza de metal pintada con polvo epoxi en la cual se alojan los contenedores. El revestimiento muestra solo las tapas y así hace más esencial y minimalista el producto. El compartimento donde se alojan los contenedores se caracteriza por un perfil embutido que, además de volver más sólida la estructura, la hace más agradable.

## Caratteristiche:

1. Struttura lamiera di acciaio zincato verniciato a polveri epossidiche realizzata in un monoblocco.
2. Alloggi dei contenitori realizzati con profilo imbutito.
3. Contenitori in polipropilene completamente riciclabile con capienza complessiva fino a 48 litri.
4. Contenitori per detersivi o accessori vari per la pulizia.
5. Disponibile per basi larghe 600 mm, 900 mm e 1200 mm.
6. Tutte le pattumiere sono dotate di un secchio con coperchio con filtro divora odore (rigenerabile con lavaggio fino a 50 volte).
7. Semplicità di installazione.
8. Facile da pulire.

## Features:

1. Structure of galvanized sheet steel and epoxy powder painted made into a single block.
2. Location for bins finished with a deep-drawn profile.
3. Containers in polypropylene recyclable with a total capacity till 48 liters.
4. Containers for detergents and various cleaning accessories.
5. Available for kitchen bases 600 mm, 900 mm and 1200 mm.
6. All systems are equipped with bins with lid and 1 anti odour filter (regenerable washing with up to 50 times).
7. Easy installation.
8. Easy to clean.

## Características:

1. Estructura de chapa de acero cincado pintada con polvo epoxi fabricada en una sola pieza.
2. Alojamiento de los contenedores fabricados con perfil embutido.
3. Contenedores de polipropileno completamente reciclables con capacidad total de hasta 48 litros.
4. Contenedores para detergentes o accesorios varios para la limpieza.
5. Disponible para bases de 600 mm, 900 mm y 1200 mm de largo.
6. Todos los cubos de basura cuentan con un recipiente con tapa con filtro antiolor (lavándola puede reutilizarse hasta 50 veces).
7. Fácil de instalar.
8. Fácil de limpiar.



Alloggi contenitori con bordi arrotondati  
 Container holders with rounded edges  
 Espacio para contenedores con bordes redondeados

Coperchio con filtro assorbi odori  
 Lid with odour absorbing filter  
 Tapa con filtro absorbe-olores



Contenitori per detersivi e oggetti  
 Containers for detergents and objects  
 Contenedores para detergentes y objetos

Disponibile in altezza 220mm  
 Available in height 220mm  
 Disponible en altura 220mm

Monoblocco in acciaio vernicato a polvere  
 Single piece made out of powder painted steel  
 Monobloque de acero barnizado a polvo



kg 4,5

Av

1

25X37X53

24

80X120X225

60



12 12

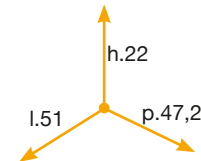

PBE22 06050



kg 6

Av

1

25X37X83

22

85X120X200

90



12 12 12

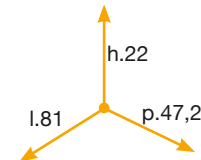

PBE22 09050



kg 8

Av

1

25X37X112

22

85X120X200

120

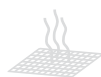

12 12 12 12

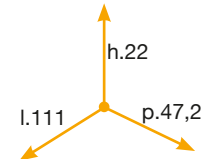

PBE22 12050



# Wizard X

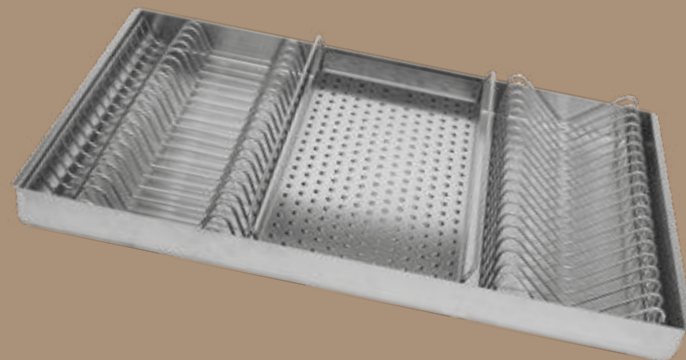

Ricercato sistema porta stoviglie da cassettone in Acciaio Inox AISI 304 composto da una vasca raccogli gocce in acciaio spazzolato elettrosaldato con all'interno una griglia porta piatti, una griglia porta coperchi in filo d'acciaio ed una bacinella forata di servizio (che può essere utilizzata anche per trasportare gli oggetti dal cassettone alla tavola). Linee minimali e materiali nobili per un prodotto top di gamma.

#### Caratteristiche:

1. Vasca raccogli gocce in acciaio spazzolato AISI 304 elettrosaldato.
2. Accessori porta piatti e porta coperchi in filo d'acciaio AISI 304
3. Bacinella forata di servizio con supporti in gomma.
4. Semplicità di installazione.
5. Facile da pulire.

Sophisticated system of plates and dishes housings made out of stainless steel AISI 304 composed of a drip tray in welded brushed steel with on the inside a plate rack, a pan rack in chrome steel wire and a perforated glass tray (which can be used also to carry items from the drawers to the table). Minimal lines and noble materials for a product top of a range.

#### Features:

1. Drip tray welded and brushed stainless steel AISI 304.
2. Accessories plate rack and lid holder made out of steel wire AISI 304
3. Perforated service tray with rubber support on the wire legs.
4. Easy installation.
5. Easy to clean.

Refinado sistema porta vajilla de cajón de Acero Inoxidable AISI 304 compuesto por un recipiente recolector de gotas de acero bruñido electrosoldado con una rejilla porta platos en su interior, una rejilla porta tapas de hilo de acero y un cubeta perforada de servicio (que puede utilizarse también para transportar los objetos del cajón a la mesa). Líneas minimalistas y materiales nobles para un producto top de gama.

#### Características:

1. Recipiente recolector de gotas de acero bruñido AISI 304 electrosoldado.
2. Accesorios porta platos y porta tapas de hilo de acero AISI 304.
3. Cubeta perforada de servicio con soportes de goma.
4. Fácil de instalar.
5. Fácil de limpiar.





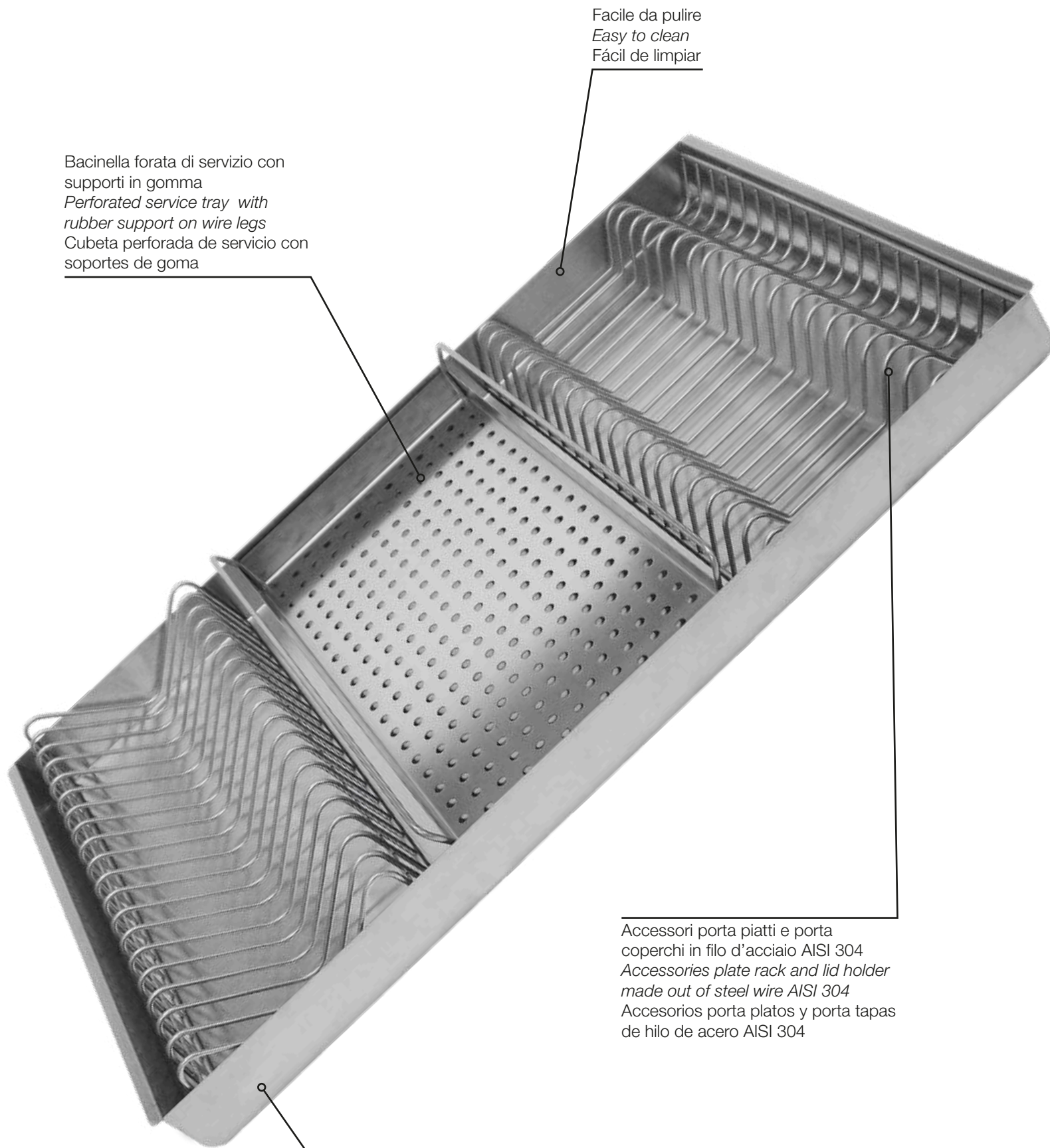

Facile da pulire  
Easy to clean  
Fácil de limpiar

Bacinella forata di servizio con supporti in gomma  
Perforated service tray with rubber support on wire legs  
Cubeta perforada de servicio con soportes de goma

Accessori porta piatti e porta coperchi in filo d'acciaio AISI 304  
Accessories plate rack and lid holder made out of steel wire AISI 304  
Accesorios porta platos y porta tapas de hilo de acero AISI 304

Vasca raccogli gocce in acciaio spazzolato AISI 304 elettrosaldato  
Drip tray welded in brushed stainless steel AISI 304  
Recipiente recolector de gotas de acero bruñido AISI 304 electrosoldado

kg	3,5	Ax
	1	9X48X37
	96	80X120X210
	45	

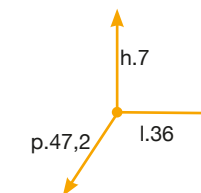

I500 X045

kg	4,5	Ax
	1	9X48X52
	64	80X120X210
	60	

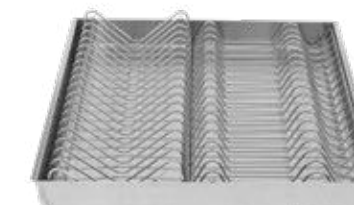
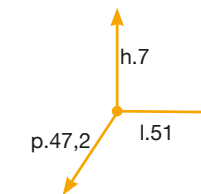

I500 X060

kg	6,5	Ax
	1	9X48X82
	32	80X120X210
	90	

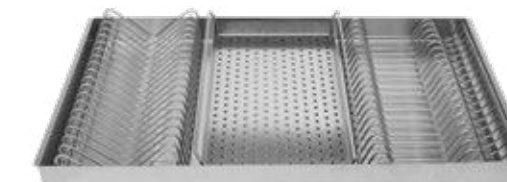
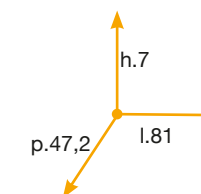

I500 X090

kg	8,5	Ax
	1	9X48X112
	32	80X120X210
	120	

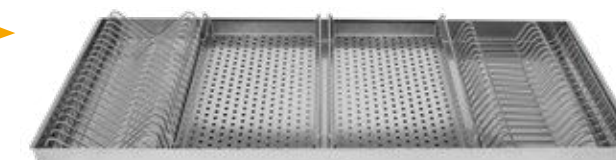
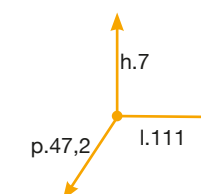

I500 X120



Bacinella forata di servizio.  
Perforated service tray.  
Cubeta perforada de servicio.

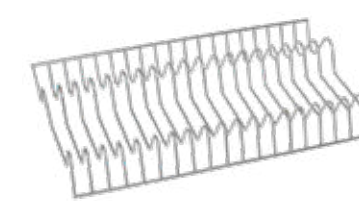

Porta piatti / coperchi  
Plate rack / lid holder  
Porta platos / porta tapas.

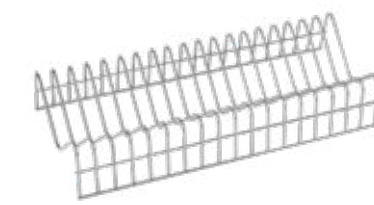

Porta piatti / coperchi  
Plate rack / lid holder  
Porta platos / porta tapas.

# Wizard P

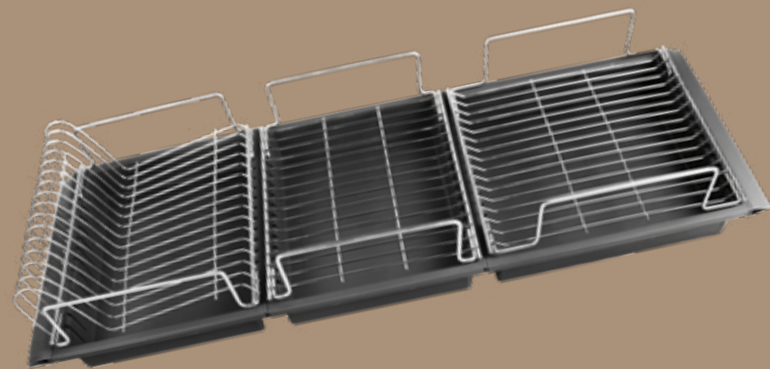

Sistema porta stoviglie da cassetto composto da una vasche in plastica che assemblate insieme fungono da un ermetico raccogli gocce con all'interno una griglia porta piatti e griglie porta bicchieri in filo d'acciaio AISI 304. Tutte le griglie possono essere utilizzate per trasportare gli oggetti dal cassetto alla tavola.

#### Caratteristiche:

1. Vasche isolanti in polipropilene dotate di guarnizioni flessibili sul perimetro.
2. Accessori porta piatti e porta bicchieri in filo d'acciaio AISI 304.
3. Disponibile per basi larghe 600 mm, 900 mm e 1200 mm
4. Semplicità d'installazione.
5. Facile da pulire.

System of plates and dishes housings consisting out of plastic trays that assembled together act as a hermetic drip container with inside a plate rack a glass rack in chrome steel wire in AISI 304. All the wire elements can be removed to transport the tableware from the drawers to the table.

#### Features:

1. Polypropylene trays equipped with flexible seals on their outside.
2. Plate rack and glass rack accessories in chrome steel wire AISI 304.
3. Available for base units 600 mm, 900 mm and 1200 mm
4. Easy installation.
5. Easy to clean.

Sistema porta vajilla de cajón compuesto por recipientes de plástico que, ensamblados juntos, cumplen la función de un hermético recolector de gotas con una rejilla porta platos en su interior y rejillas porta vasos de hilo de acero AISI 304. Se pueden usar todas las rejillas para transportar los objetos del cajón a la mesa.

#### Características:

1. Recipientes aislantes de polipropileno que cuentan con juntas flexibles en el perímetro.
2. Accesorios porta platos y porta vasos de hilo de acero AISI 304.
3. Disponible para bases de 600 mm, 900 mm y 1.200 mm de largo.
4. Fácil de instalar.
5. Fácil de limpiar.



Accessori porta piatti e porta bicchieri  
in filo d'acciaio AISI 304 trasportabili  
*Plate rack and glass rack accessories  
in chrome steel wire AISI 304  
transportable*  
Accesorios porta platos y porta vasos  
de hilo de acero AISI 304 transportable

Guarnizione flessibile blocca  
vassoio su tre lati  
*Flexible seal to block trays  
on three sides*  
Junta flexible bloqueadora  
de bandeja en tres lados

Facile da pulire  
*Easy to clean*  
Fácil de limpiar

Vasche collegabili fornite in kit  
*The kit includes attachable trays*  
Cubetas encajables entregadas en kit

Vasche isolanti in polipropilene dotate di guarnizioni flessibili sul perimetro  
*Polypropylene trays equipped with flexible seals on their outside*  
Recipientes aislantes de polipropileno que cuentan con juntas flexibles en el perímetro

kg	2,3	Ap
	1	33X47X25
	30	80X120X215
	60	

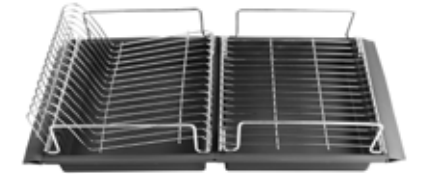
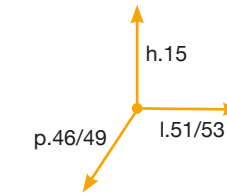

1500 P060

kg	3,1	Ap
	1	35X47X31
	30	80X120X225
	90	

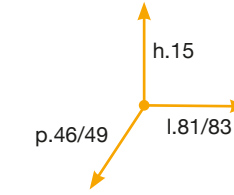

1500 P090

kg	4,1	Ap
	1	43X47X31
	25	80X120X230
	120	

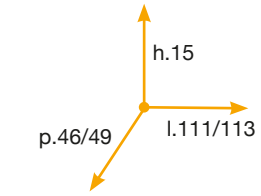

1500 P120



# Wood Line

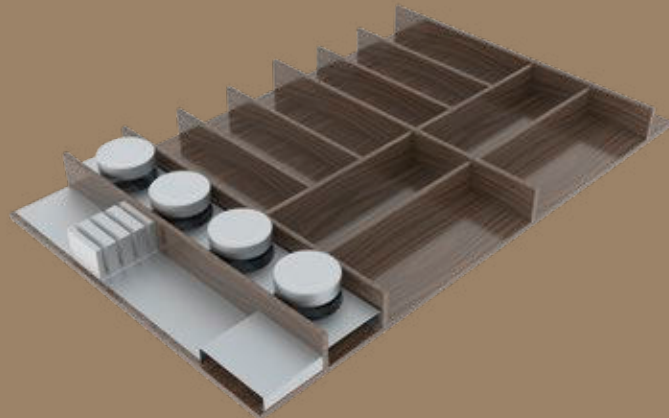

Linea di porta posate da cassetto prodotta in faggio massello in MDF nobilitato dal design semplice e minimale. I divisori realizzati in 3 altezze differenti conferiscono un aspetto ricercato e ne agevolano l'utilizzo. La serie è disponibile nelle finiture Faggio naturale, Faggio tinto nero e Faggio laccato bianco. Tutti i vani contenitori sono studiati per ottimizzare gli spazi e permettono l'inserimento degli optional in acciaio inox AISI 430 quali porta coltelli o porta spezie con vasetti in vetro temperato.

#### Caratteristiche:

1. Realizzato in MDF nobilitato completamente riciclabile.
2. Disponibile per cassette di larghezza 450 mm, 600 mm, 900 mm e 1200 mm.
3. I divisori in faggio massello hanno uno spessore di 8 mm.
4. Disponibile nelle finiture faggio naturale, faggio tinto nero o faggio laccato bianco.
5. Le vernici utilizzate sono tutte eco sostenibile e certificate per alimenti.
6. Disponibile come optional gli accessori in acciaio inox AISI 430 quali porta coltelli o i vasetti porta spezie in vetro temperato.
7. Semplicità di installazione.
8. Facile da pulire.

Line of cutlery trays produced in ennobled beech MDF wood with a simple and minimal design. The dividers are made in 3 different heights which give it a sophisticated look and facilitate the use. This series is available in natural beech finish, stained black beech and white lacquered beech. All compartments are designed to maximize space and allows the insertion of the optional in stainless steel AISI 430 like knives block or glass (tempered) spice jars.

#### Features:

1. Made of ennobled beech MDF (recyclable).
2. Available for drawers with width of 450 mm, 600 mm, 900 mm and 1200 mm.
3. The dividers are of solid beech with a thickness of 8 mm.
4. Available in natural beech, stained black beech or white lacquered beech.
5. The paints used are environmentally sustainable and certified for food.
6. As optional available stainless steel AISI 430 accessories such as knife block or spice jars glass (tempered) tray.
7. Easy installation.
8. Easy to clean.

Línea de porta cubiertos de cajón fabricada MDF de haya con melamina con un diseño simple y minimalista. Los divisorios realizados en 3 alturas diferentes le otorgan un aspecto refinado y facilitan su uso. La serie está disponible en los acabados Haya natural, Haya teñida de negro y Haya laqueada de blanco. Todos los compartimientos contenedores han sido diseñados para optimizar los espacios y permiten introducir los opcionales de acero inoxidable AISI 430, como porta cuchillos o especieros con envases de vidrio templado.

#### Características:

1. Realizado MDF de haya con melamina, completamente reciclable.
2. Disponible para cajones de 450 mm, 600 mm, 900 mm y 1.200 mm de largo.
3. Los divisorios de haya maciza tienen un espesor de 8 mm.
4. Disponible en los acabados haya natural, haya teñida de negro o haya laqueada de blanco.
5. Las pinturas utilizadas son todas ecosostenibles y certificadas para alimentos.
6. Están disponibles como opcional los accesorios de acero inoxidable AISI 430, como porta cuchillos o especieros de vidrio templado.
7. Fácil de instalar.
8. Fácil de limpiar.



# Wood Line



MDF faggio nobilitato naturale  
Natural ennobled beech MDF  
MDF de haya con melaminado natural



MDF nobilitato grigio RAL7012  
MDF ennobled RAL7012 Grey  
MDF melaminado gris RAL7012



MDF nobilitato finitura bianco  
MDF ennobled white finish  
MDF melaminado acabado blanco



Accessorio porta spezie in plexiglass con 4  
vasetti in vetro temperato  
Accessory plexiglass AISI 430 spice tray with  
jars made out of tempered glass  
Accesorio especiero de plexiglass y envases de  
vidrio templado

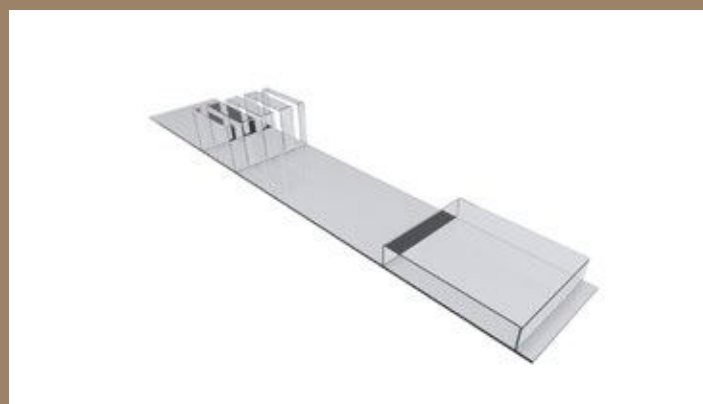

Accessorio porta coltelli in plexiglass  
Accessory plexiglass knives block  
Accesorio porta cuchillos de plexiglas

MDF faggio nobilitato naturale  
Natural ennobled beech MDF  
MDF de haya con melaminado natural

kg 1,3

1	6X48X34
180	80X120X220

45

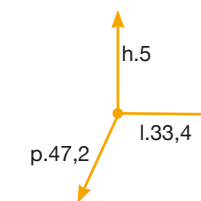

PLA N50045 --

MDF faggio nobilitato naturale  
Natural ennobled beech MDF  
MDF de haya con melaminado natural

kg 2,3

1	6X48X49
120	80X120X215

60

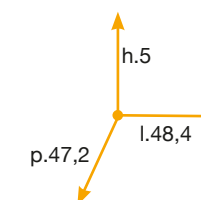

PLA N50060 --

Predisposto per più accessori - Can contain accessories - Preparado para mas accesorios

MDF faggio nobilitato naturale  
Natural ennobled beech MDF  
MDF de haya con melaminado natural

kg 4,3

1	6X48X79
80	80X120X210

90

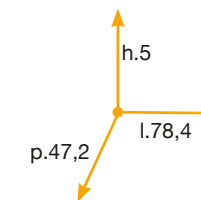

PLA N50090 --

Predisposto per più accessori - Can contain accessories - Preparado para mas accesorios

MDF faggio nobilitato naturale  
Natural ennobled beech MDF  
MDF de haya con melaminado natural

kg 5,3

1	6X48X109
52	80X120X210

120

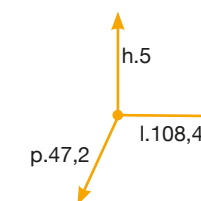

PLA N50120 --

Predisposto per più accessori - Can contain accessories - Preparado para mas accesorios



**PLE PS**  
Porta spezie  
Spice tray.  
Especiero.



**PLE PC**  
Porta coltelli  
Knife block  
Porta-cuchillos

PLA 050045 --

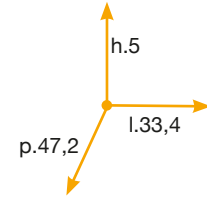

MDF nobilitato grigio RAL7012 MDF ennobled Grey RAL7012 MDF melaminado gris RAL7012	
1,3	
1	6X48X34
180	80X120X220
45	

MDF nobilitato finitura bianco MDF ennobled white finish MDF melaminado acabado blanco	
1,3	
1	6X48X34
180	80X120X220
45	

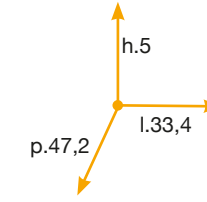

PLC M5004 --

PLA 050060 --

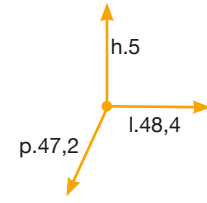

MDF nobilitato grigio RAL7012 MDF ennobled Grey RAL7012 MDF melaminado gris RAL7012	
2,3	
1	6X48X49
120	80X120X215
60	

MDF nobilitato finitura bianco MDF ennobled white finish MDF melaminado acabado blanco	
2,3	
1	6X48X49
120	80X120X215
60	

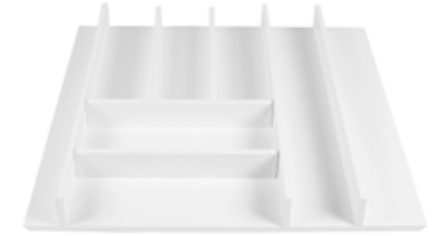
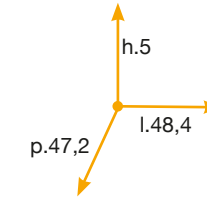

PLC M50060 --

Predisposto per più accessori - Can contain accessories - Preparado para mas accesorios

Predisposto per più accessori - Can contain accessories - Preparado para mas accesorios

PLA 050090 --

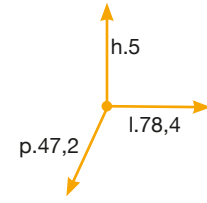

MDF nobilitato grigio RAL7012 MDF ennobled Grey RAL7012 MDF melaminado gris RAL7012	
4,3	
1	6X48X79
80	80X120X210
90	

MDF nobilitato finitura bianco MDF ennobled white finish MDF melaminado acabado blanco	
4,3	
1	6X48X79
80	80X120X210
90	

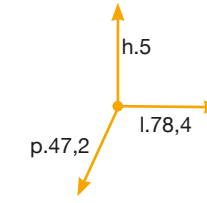

PLC M50090 --

Predisposto per più accessori - Can contain accessories - Preparado para mas accesorios

Predisposto per più accessori - Can contain accessories - Preparado para mas accesorios

PLA 050120 --

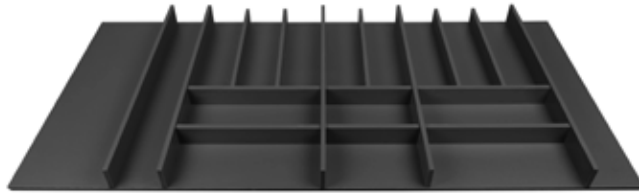

MDF nobilitato grigio RAL7012 MDF ennobled Grey RAL7012 MDF melaminado gris RAL7012	
5,3	
1	6X48X109
52	80X120X210
120	

MDF nobilitato finitura bianco MDF ennobled white finish MDF melaminado acabado blanco	
5,3	
1	6X48X109
52	80X120X210
120	

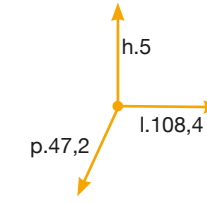

PLC M50120 --

Predisposto per più accessori - Can contain accessories - Preparado para mas accesorios

Predisposto per più accessori - Can contain accessories - Preparado para mas accesorios



**PLE PS**

Porta spezie  
Spice tray.  
Especiero.



**PLE PC**

Porta coltelli  
Knife block  
Porta-cuchillos



**PLE PS**

Porta spezie  
Spice tray.  
Especiero.



**PLE PC**

Porta coltelli  
Knife block  
Porta-cuchillos

# Flexo

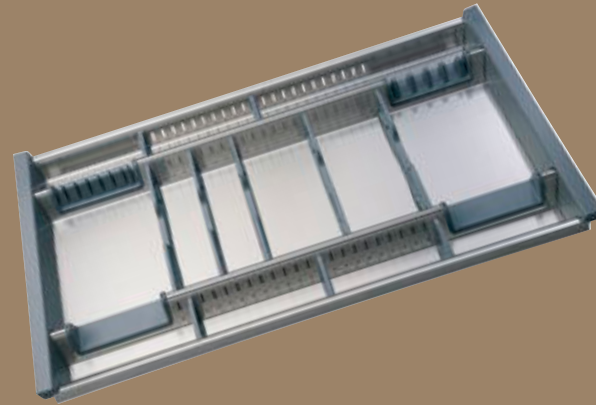

Portaposate in acciaio inox satinato (AISI 430) dal design elegante e curato.

Il fondo in acciaio satinato agevola la pulizia, i divisori in plastica sono rimovibili e permettono di personalizzare gli spazi.

Flexo si adatta ad ogni cassetto grazie alle sponde laterali mobili.

Nato dalla collaborazione con i designers "Lineaguida".

Cutlery tray made of stainless steel (AISI 430) with an elegant and elaborated design.

The satin stainless steel base makes it easy to clean. The plastic dividers are removable and allow you to customise the space.

Flexo fits in all drawers thanks to its movable sides.

Developed in collaboration with the "Lineaguida" designers.

Bandejas para cubiertos de acero inoxidable satinado (AISI 430) de diseño elegante y cuidado.

El fondo de acero satinado agiliza la limpieza, los compartimentos de plástico se pueden quitar y permiten personalizar los espacios.

Flexo se adapta a todos los cajones gracias a los lados laterales móviles.

Nacido de la colaboración con los diseñadores "Lineaguida".

## Caratteristiche:

1. Prodotto in acciaio inox e plastica completamente riciclabile.
2. Disponibile per cassette da 400 mm. a 1200 mm.
3. Fissaggio senza bisogno di forature.
4. I divisori in plastica, disponibili in vari colori, si possono spostare adattandosi alle diverse esigenze di spazio.
5. Facile da pulire.

## Features:

1. Stainless steel and recyclable plastic product.
2. Availability of 400 mm. to 1200 mm drawers.
3. Can be assembled without the need of fixing materials.
4. The plastic dividers, which are available in various colours, can be moved to adapt to different space requirements.
5. Easy to clean.

## Características:

1. Producto de acero inoxidable y plástico completamente reciclable.
2. Disponible para cajones de 400 mm. a 1.200 mm.
3. Fijación sin necesidad de perforar.
4. Los compartimentos de plástico, disponibles en varios colores, se pueden cambiar adaptándose a las diferentes exigencias de espacio.
5. Fácil de limpiar.



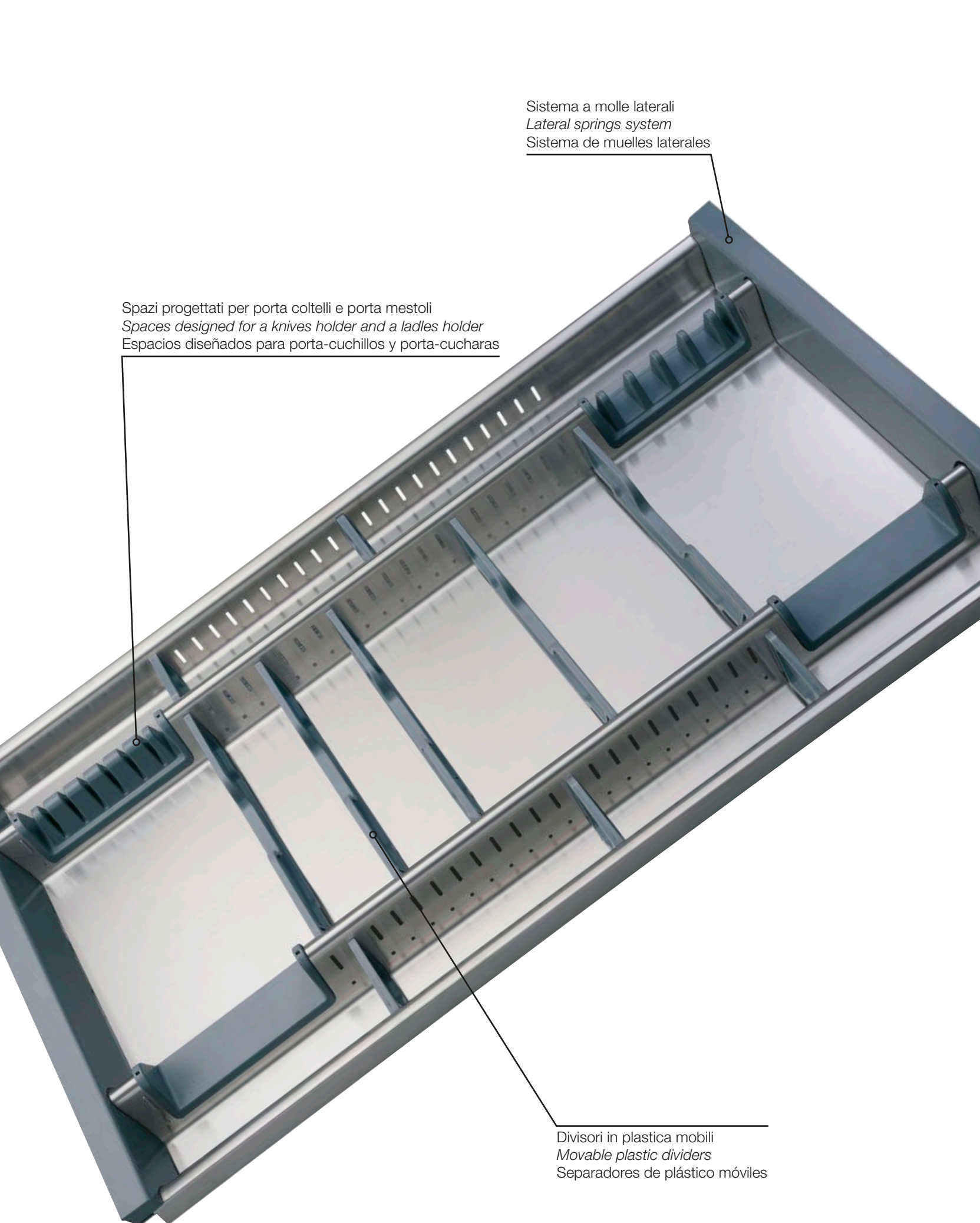

Sistema a molle laterali  
*Lateral springs system*  
 Sistema de muelles laterales

Spazi progettati per porta coltelli e porta mestoli  
*Spaces designed for a knives holder and a ladles holder*  
 Espacios diseñados para porta-cuchillos y porta-cucharas

Divisori in plastica mobili  
*Movable plastic dividers*  
 Separadores de plástico móviles

# Flexo



Sistema a molle laterali permette il fissaggio all'interno del cassetto  
*Lateral springs system which allows adaptation inside drawers*  
 Sistema de muelles laterales que le permite adaptarse dentro del cajón



I divisori in plastica, disponibili in vari colori, si possono spostare adattandosi alle diverse esigenze di spazio  
*The plastic dividers, which are available in various colours, can be moved to adapt to different space requirements*  
 Los compartimentos de plástico, disponibles en varios colores, se pueden cambiar adaptándose a las diferentes exigencias de espacio



Spazi progettati per porta coltelli e porta mestoli  
*Spaces designed for a knives holder and a ladles holder*  
 Espacios diseñados para porta-cuchillos y porta-cucharas



Finitura grigio orione  
*Orion gray finish*  
 Orion gris acabado





R240/S C11

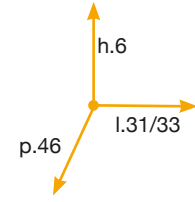

	C11
	1,95
	AxS+P
	1
	38X6,5X48
	128
	80X120X215
	40

	C11
	3,4
	AxS+P
	1
	83X6,5X48
	54
	80X120X215
	90

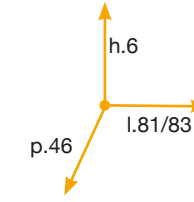

R290/S C11

R245/S C11

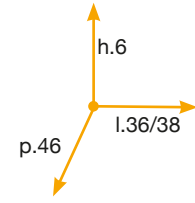

	C11
	2
	AxS+P
	1
	38X6,5X48
	128
	80X120X215
	45

	C11
	3,6
	AxS+P
	1
	113X6,5X48
	32
	80X120X215
	100

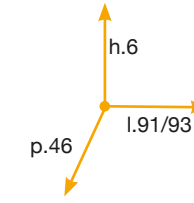

R300/S C11

R250/S C11

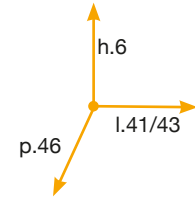

	C11
	2,05
	AxS+P
	1
	53X6,5X48
	100
	80X120X215
	50

	C11
	4,5
	AxS+P
	1
	113X6,5X48
	32
	80X120X215
	120

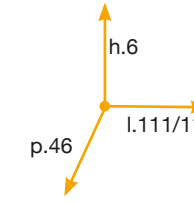

R320/S C11

R260/S C11

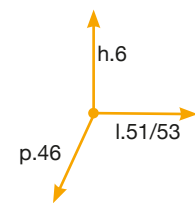

	C11
	2
	AxS+P
	1
	53X6,5X48
	100
	80X120X215
	60

	C11
	3,1
	AxS+P
	1
	83X6,5X48
	54
	80X120X215
	80

R280/S

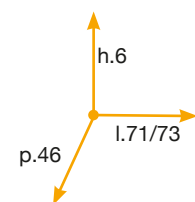

	C11
	3,1
	AxS+P
	1
	83X6,5X48
	54
	80X120X215
	80

# Uppo



Linea di portaposate in polipropilene con linee morbide e design moderno. Studiato per razionalizzare al massimo gli spazi all'interno del cassetto e aumentarne la funzionalità. Nato dalla collaborazione con i designer "Lineaguida".

#### Caratteristiche:

1. Polipropilene completamente riciclabile.
2. Piano leggermente inclinato per facilitare la presa delle posate.
3. Disponibile per cassetti da 300 mm. a 1200 mm. 4. A partire dal cassetto di 600 mm. Porta coltelli standard inserito.
4. Taglio personalizzato a richiesta.
5. Colori disponibili bianco, grigio e metallizzato.

Cutlery tray product line made of polypropylene with a soft shapes and a modern design. Designed for maximum rationalisation of space inside drawers and to increase functionality. Developed in collaboration with the "Lineaguida" designers.

#### Features:

1. Completely recyclable Polypropylene.
2. Slightly angled to facilitate gripping of the cutlery.
3. Available in sizes for 300 mm to 1200 mm drawers.
4. A standard knife holder is included from the 600 mm drawer upwards.
5. Customised sizing on request.
6. Available colours: white, grey and metallic.

Línea de bandeja para cubiertos en polipropileno con líneas suaves y diseño moderno. Estudiado para optimizar al máximo los espacios del cajón y aumentar su funcionalidad. Nacido de la colaboración con los diseñadores "Lineaguida".

#### Características:

1. Polipropileno completamente reciclable.
2. Plano ligeramente inclinado para poder coger los cubiertos de forma más fácil.
3. Disponible para cajones de 300mm. a 1200mm.
4. A partir del cajón de 600mm., se incluye un porta-cuchillos estándar.
5. Corte personalizado a petición.
6. Colores disponibles blanco, gris y metalizado.



R130 C97 5

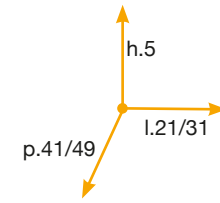

C97	
4,8	P
15	31,5X27X49
720	85X125X215
30	

R180 C97 45

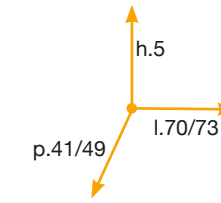

C97	
10,3	P
10	50X18X74
200	85X120X210
80	

R140 C97 10

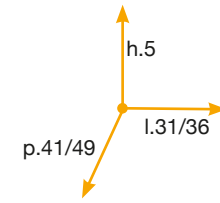

C97	
6,3	P
15	39X27X49
480	85X120X210
40	

R188 C97 50

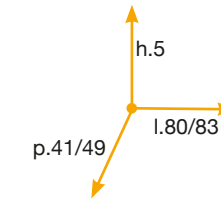

C97	
10,3	P
10	50X18X84
200	85X120X210
90	

R145 C97 20

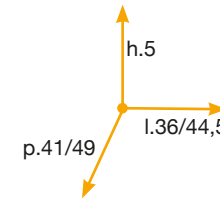

C97	
5,3	P
10	45X17X49
480	85X120X210
45	

R195 C97 60

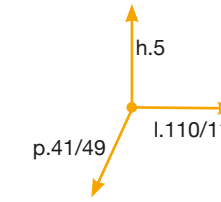

C97	
16,3	P
10	50X18X114
160	85X120X210
120	

R160 C97 30

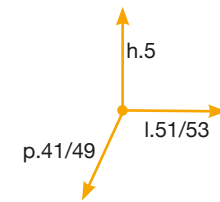

C97	
6,3	P
10	53,5X18X49
320	85X120X210
60	



Vasca inclinata per  
facilitare l'utilizzo  
*Angled basin for easy use*  
Cubeta inclinada para  
facilitar el uso



Porta coltelli  
*Knives holder*  
Porta-cuchillos

# Bridge

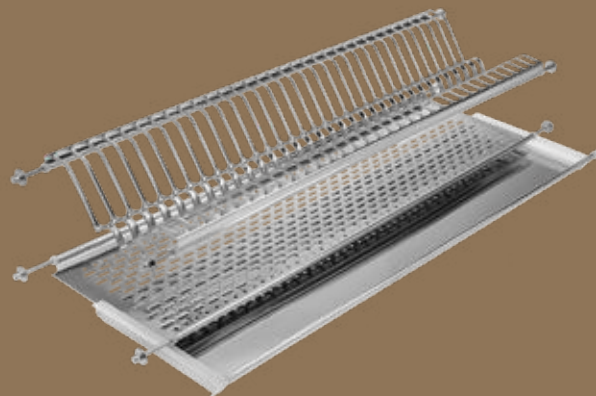

Scolapiatti in acciaio inox AISI 304 o in alternativa, nel più economico acciaio inox AISI 430. Accessori per pensili o per piano cucina prodotti tramite processo di stampaggio. Sono disponibili vari design sia nel porta piatti, sia nel porta bicchieri che nella vaschetta raccogli gocce.

Stainless steel dish drainer AISI 304 or alternatively, in the more economical stainless steel AISI 430. Accessories for wall cabinets or kitchen top products through molding process. They are available in various designs both plate racks and glass racks and the drip trays.

Escurreplatos de acero inoxidable AISI 304 o, como alternativa, de acero inoxidable AISI 430, más económico. Accesorios para alacenas o para encimeras de cocina fabricados mediante proceso de moldeo. Hay varios diseños disponibles, tanto en el porta platos como en el porta vasos y en el recipiente recolector de gotas.

## Caratteristiche:

1. Prodotto in acciaio inox (AISI304 o AISI430) completamente riciclabile.
2. Disponibile per pensili da 400 a 1200 mm.
3. Disponibili 2 modelli di vaschette raccogli gocce: una completamente in acciaio e l'altra con terminali in plastica e bordo rialzato.
4. Sistemi di fissaggio con registrabili a molla o a vite (fori di 5 o 10 mm) o con perno fisso per telaio.
5. Disponibile in acciaio inox AISI 304 o, in alternativa, nel più economico AISI 430.
6. Disponibili accessori in plastica quali: portaposate, porta piatti e porta piattini da inserire sul piano del porta bicchieri.
7. Facile da pulire.

## Features:

1. A stainless steel product (AISI 304 or AISI 430) completely recyclable product.
2. Available for cabinets in sizes ranging from 400 to 1200 mm.
3. Availability of 2 drip trays models: one made completely of steel and the other with plastic ends with raised edges.
4. Fastening systems with spring or screw fixations (5 or 10 mm holes) or with a fixed pivot for the frame.
5. Available in AISI 304 stainless steel, or alternatively, in the less expensive AISI 430 stainless steel.
6. Availability of plastic accessories such as cutlery holders, plate and small plate holders to be inserted on the cups holder level.
7. Easy to clean.

## Características:

1. Producto de acero inoxidable (AISI304 o AISI430) completamente reciclable.
2. Disponible para colgantes de 400 a 1200mm.
3. Disponibles 2 modelos de cubetas para recoger gotas: una completamente de acero y la otra con terminales de plástico y borde realzado.
4. Sistemas de fijación con extensibles de muelle o tornillo (agujeros de 5 o 10mm) o con tuerca fija para marco.
5. Disponible en acero inoxidable AISI 304 o, como alternativa, en el más económico AISI 430.
6. Disponibles accesorios de plástico como: bandejas para cubiertos, porta-platos, porta-plateos pequeños para insertar en el plano del porta-vasos.
7. Fácil de limpiar.



Individuate il modello di scolapiatti tra le varie soluzioni fotografate nelle pagine successive e selezionate la colonna relativa al tipo di materiale e al sistema di attacco; in questo modo otterrete il codice generico. Al posto dei caratteri XX inserire la misura degli scolapiatti che desiderate ordinare tra quelle disponibili riportate di seguito:  
36 - 41 - 46 - 51 - 56 - 61 - 66 - 71  
76 - 81 - 86 - 91 - 96 - 116

Choose the dish drainer model among the various solutions photographed into the following pages and select the column referring to material type and fixing system. In this way you will obtain the general code. Replace the XX with the dish drainer sizes that you wish to order within the following available sizes:  
36 - 41 - 46 - 51 56 - 61 - 66 - 71  
76 - 81 - 86 - 91 - 96 - 116

Elija el modelo de escurrer platos que desee entre las diversas soluciones mostradas en las fotografías de las siguientes páginas y seleccione la columna correspondiente al tipo de material y al sistema de sujeción; de este modo, obtendrá el código general. En lugar de las XX, inserte la medida de los escurrer platos que desee solicitar, a continuación se presentan las opciones disponibles:  
36 - 41 - 46 - 51 56 - 61 - 66 - 71  
76 - 81 - 86 - 91 - 96 - 116

1850 CB



		Ax	
	10		52X39X--
	160/120/80		80X120X215

1850 COMBI



		Ax	
	10		52X39X--
	160/120/80		80X120X215
			<b>VASISTAS</b>

1800 CB



		Ax	
	10		52X39X--
	160/120/80		80X120X215

1611 COMBI



		Ax	
	10		52X39X--
	160/120/80		80X120X215
			<b>VASISTAS</b>

		Ax	
	10		52X39X--
			80X120X215

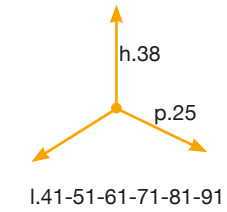

1813

Disponibile nelle larghezze di 41-51-61-71-81-91 cm. - Available in widths of 41-51-61-71-81-91 cm. - Disponible en anchos de 41-51-61-71-81-91cm.

		Ax	
	5		44X48X29
	1		80X120X235
	30		

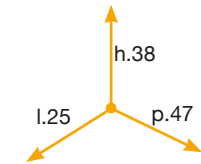

1610

		Ax	
	6,1		41X30X42
	1		80X120X220
	30		

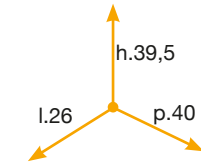

1617



Attacco a molla V01 (10 mm.)  
Attacco a molla V02 (5 mm.)

Spring-loaded pin fixation V01 (10 mm.)  
Spring-loaded pin fixation V02 (5 mm.)

Sujeción con muelle V01 (10 mm.)  
Sujeción con muelle V02 (5 mm.)



Attacco a vite V03 (10 mm.)  
Attacco a vite V04 (5 mm.)

Screwing pin fixation V03 (10 mm.)  
Screwing pin fixation V04 (5 mm.)

Sujeción con tornillo V03 (10 mm.)  
Sujeción con tornillo V04 (5 mm.)

TAR --



Telaio in alluminio registrabile.  
Adjustable aluminum frame.  
Bastidor de aluminio regulable.

AI

--36 --76  
--41 --86  
--46 --96  
--56 --116  
--66

Varie misure - Various sizes - Varias medidas

TARM --



Telaio in alluminio registrabile manigliato.  
Adjustable aluminum frame for cabinet without handle.  
Bastidor de aluminio regulable con manijas.

AI

--36 --76  
--41 --86  
--46 --96  
--56 --116  
--66

Varie misure - Various sizes - Varias medidas

TRS --



Traversa anteriore / posteriore in alluminio con terminali in plastica.  
Aluminum front / rear cross with plastic terminals.  
Travesaño delantero / trasero de aluminio con terminales de plástico.

AI

--36 --76  
--41 --86  
--46 --96  
--56 --116  
--66

Varie misure - Various sizes - Varias medidas

IFA---



Fondo salva base in alluminio.  
Aluminum under cabinet sink protection.  
Fondo de protección de la base de aluminio.

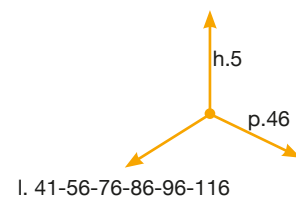

AI

--41 --76  
--46 --86  
--56 --96  
--66 --116

Varie misure - Various sizes - Varias medidas



# Cover Box



Frutto di un lungo studio e di una continua ricerca per conciliare al meglio estetica e funzionalità, i secchi Coverbox, sono caratterizzati da cura nei dettagli e robustezza. (designed by "Lineaguida").

The result of long term study and a continuous search for the best balance between aesthetics and functionality, attention to detail and robustness are the features of Coverbox buckets. (designed by "Lineaguida").

Fruto de un largo estudio y de una continua investigación para conciliar del mejor modo posible estética y funcionalidad, los cubos Coverbox se caracterizan por el cuidado de los detalles y la solidez. (Diseño Lineaguida).

## Caratteristiche:

1. Plastica completamente riciclabile.
2. Incisioni centrali, che permettono l'inserimento anche di due sacchetti per secchio.
3. Il sistema dei manici "multifunzione" è disponibile in vari colori, permette di impugnare il secchio senza togliere il coperchio e funziona anche da bloccasacchetto.
4. Disponibili in varie dimensioni: 5 misure in altezza, 3 in larghezza.
5. Possono essere forniti di coperchio semplice o con filtro anti-odore (rigenerabile con lavaggio fino a 50 volte).

## Features:

1. Completely recyclable plastic.
2. Incisions in the middle which also allow the insertion of two bags per bucket.
3. The "multi-function" handles system is available in various colours, and it allows you to take hold of the bucket without removing the lid. It also blocks the bags.
4. Available in various sizes: 5 in height, 3 in width.
5. May be supplied with a simple lid or one with an odour filter (which can be regenerated by washing for up to 50 times).

## Características:

1. Plástico completamente reciclable.
2. Incisiones centrales que permiten también introducir dos bolsas de basura por cubo.
3. El sistema de las asas "multifunción" está disponible en varios colores, permite sujetar el cubo sin quitar la tapa, y funciona también para fijar las bolsas de basura.
4. Disponibles en varios tamaños: 5 medidas en altura, 3 en ancho.
5. Se pueden entregar con tapa simple o con filtro anti-olor (regenerable con lavado hasta 50 veces).



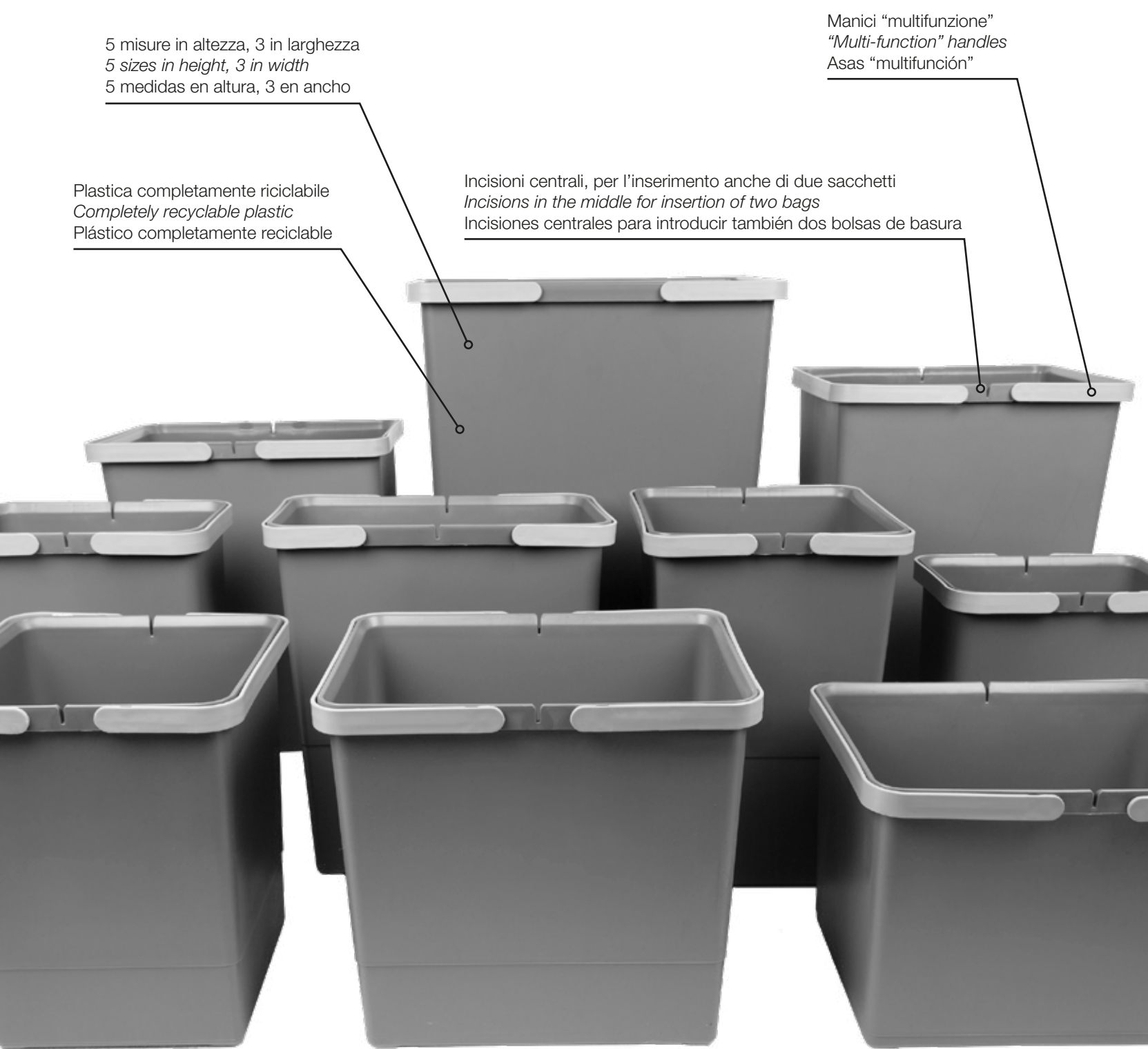

5 misure in altezza, 3 in larghezza  
5 sizes in height, 3 in width  
5 medidas en altura, 3 en ancho

Plastica completamente riciclabile  
Completely recyclable plastic  
Plástico completamente reciclable

Incisioni centrali, per l'inserimento anche di due sacchetti  
Incisions in the middle for insertion of two bags  
Incisiones centrales para introducir también dos bolsas de basura

Manici "multifunzione"  
"Multi-function" handles  
Asas "multifunción"

# Cover Box

Filtro anti-odore rigenerabile con lavaggio a mano o a macchina ogni 3 - 5 mesi fino a 20 volte.

*Anti-odour filter which can be regenerated with washing by hand or machine every 3-5 months for up to 20 times.*

Filtro anti-olor regenerabile con lavado a mano o a máquina cada 3-5 meses hasta 20 veces.

Il sistema dei manici "multifunzione", permette di impugnare il secchio senza togliere il coperchio e funziona anche da blocca-sacchetto.

*The "multi-function" handles system is available in various colours, and it allows you to take hold of the bucket without removing the lid. It also blocks the bags.*

El sistema de las asas "multifunción" está disponible en varios colores, permite agarrar el cubo sin quitar la tapa, y funciona también para fijar las bolsas de basura.

Le incisioni centrali, permettono l'inserimento anche di due sacchetti per secchio.

*Incisions in the middle also allow the insertion of two bags per bucket.*

Las incisiones centrales permiten también introducir dos bolsas de basura por cubo.

Etichette resinatè multicolore resistenti all'acqua, opzionabili e applicabili sui coperchi coverbox.

*Water-resistant multicolored resin labels, optional and applicable on the coverbox lids.*

Etiquetas de resina multicolor resistentes al agua, opcionales y aplicables en las tapas de la caja de cubierta.



## Coperchi - Lids - Tapas

PTM SG



STA PT CG

PTM SE



STA PT CE

PTM SM



STA PT CM

PTM SS



STA PT CS

PTM SP



STA PT CP



PTP CG



PTP CE



PTP CM



PTP CS



PTP CP





PTM SG22

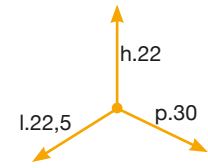

C97	C08
0,53	P
150	90X80X110
300	80X114X195

12

C97	C08
0,47	P
180	90X80X110
360	80X114X195

10

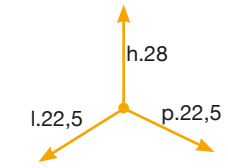

PTM SM28

PTM SG28

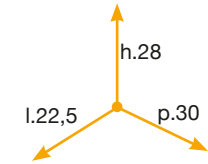

C97	C08
0,64	P
135	90X80X110
270	80X114X195

15

C97	C08
0,57	P
160	90X80X110
320	80X114X195

12

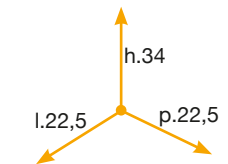

PTM SM34

PTM SG34

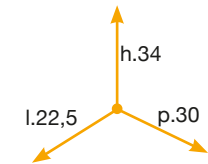

C97	C08
0,72	P
120	90X80X110
240	80X114X195

18

C97	C08
0,44	P
240	90X80X110
480	80X114X195

8

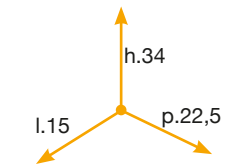

PTM SP34

PTM SG44

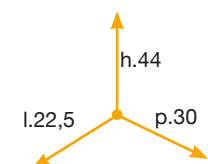

C97	C08
0,81	P
105	90X80X110
210	80X114X195

24

C97	C08
0,39	P
270	90X80X110
540	80X114X195

6

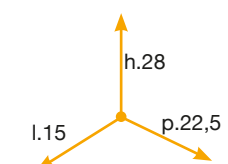

PTM SP28

PTM SE53



C97	C08
0,81	P
44	90X80X110
88	80X114X195

35

C97	C08
0,57	P
168	90X80X110
336	80X114X195

12

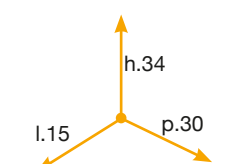

PTM SS34

# Bag Box



Nel corso degli anni la Elletipi ha realizzato contenitori per ogni necessità. I secchi Bag Box si contraddistinguono per la robustezza e l'ampia offerta di dimensioni disponibili.

Over the years Elletipi has made containers for all needs. The Bag Box buckets are characterised by their robustness and the wide range of available sizes.

A lo largo de los años, Elletipi ha realizado contenedores para todas las necesidades. Los cubos Bag Box se contradicen por la solidez y la amplia oferta de tamaño disponible.

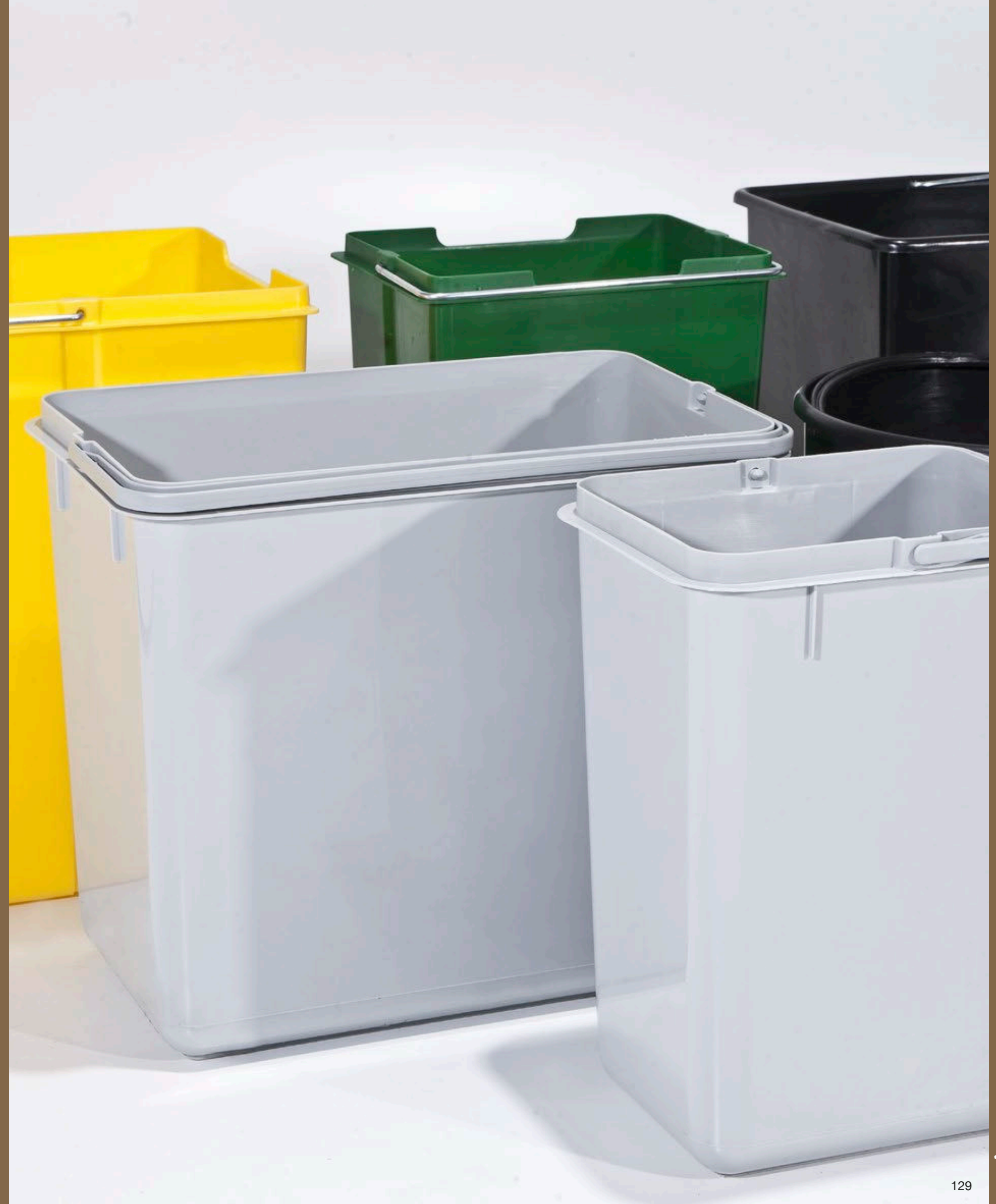

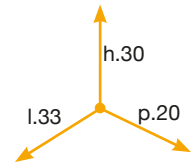

C97 P  
 0,5 P  
 120 80X120X105

18

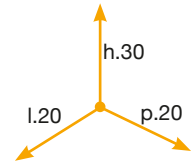

C97 P  
 0,26 P  
 240 80X120X105

8



C97 P  
 P

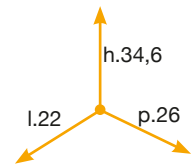

C01 C81 C82 C83 M  
 0,72 P  
 105 80X120X105

16

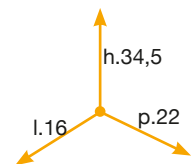

C01 C81 C82 C83 M  
 0,46 P  
 176 80X120X105

10

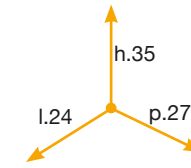

C99 M  
 0,66 P  
 360 100X120X190

17



C99 P  
 0,35 P  
 600 100X120X175

10

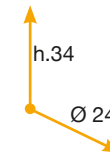

C99 P  
 0,5 P  
 600 100X120X190

12

**ELLETIPI s.r.l.**

via Lombardia, 4  
53036 Poggibonsi (Siena)  
ITALIA

Tel. +39 0577 936360

Fax +39 0577 933829

**elletipi@elletipi.com**

**www.elletipi.com**

**elletipi**  
1 9 5 4



**Edition 2021**

Kitchen Aurora Cucine - Cecchi Cucine  
Photo Enrico Bernazzi - Mario Corsini - Fabrizio Gaggelli - Bruno Bruchi - Matteo Vanni  
Print federighi.com  
Rendering PiùCommunication

# Legenda - Key - Leyenda



Colore - Color - Color



Manico - Handle - Asa

P Plastica - Plastic - Plástico

M Metallo - Metal - Metal



Guida - Runner - Guía

P Plastica - Plastic - Plástico

M Metallo - Metal - Metal

MR Metallo ritorno - Metal runner with return  
Metal cierre con vuelta

MRS Metallo chiusura assistita ed ammortizzata -  
Metal runner with soft closing  
Metal cierreasistido y ammortizzata

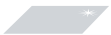

Finitura - Finish - Acabado

P Plastica - Plastic - Plástico

AX Acciaio Inox - Stainless steel - Acero Inoxidable

AL Alluminio - Aluminum - Aluminio

AV Lamiera Verniciata - Varnished sheet metal  
Chapa Barnizada

ACR Acciaio Cromo - Chromium steel  
Acero Cromado

AXS Acciaio Inox Satinato - Satiny stainless steel  
Acero Inoxidable Satinado

SR Senza riferimento fotografico - Without photographic reference  
Sin una referencia fotográfica

AP Plastica + Acciaio inox satinato - Plastic + Stainless steel  
Plástico + Acero Inoxidable



Apertura automatica del coperchio  
Automatic lid opening  
Apertura automática de la tapa



Estrazione totale - Total extraction  
Totalmente extraíble

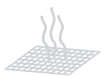

Filtro rigenerabile anti-odore  
Anti-odour filter that can be regenerated  
Filtro rigenerabile anti-olor



Peso lordo  
Gross weight  
Peso bruto

10

12

Capacità dei secchi in litri  
Capacity of buckets in liters

6

8

10

Capacidad de los cubos en litros

12

15

16

18

24

35



Mobile con anta + dimensione minima  
Kitchen cupboard with door + minimum size  
Mueble con puerta + tamaño mínimo



Mobile con cassetto + dimensione minima  
Kitchen cabinet with drawer + minimum size  
Mueble con cajón + tamaño mínimo



Mobile angolo + dimensione minima  
Angular Kitchen cupboard  
Mueble esquina + tamaño mínimo



N° pezzi per imballo - N° of pieces per package  
N° de piezas por caja



Dimensione imballo - Package size  
Dimensiones caja



N° pezzi per pallet - N° of pieces per pallet  
N° de piezas por pallet



Dimensione pallet - Pallet size  
Dimensiones pallet

## Colore - Colors - Colores

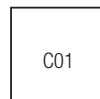

C01



C08



C09



C11



C12

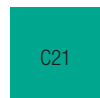

C21



C55



C81



C82



C83



C97



C99



etichette resinate per raccolta differenziata  
resin-coated labels for separate waste collection  
etiquetas con revestimiento de resina para la recogida selectiva de residuos

I colori del catalogo sono indicativi.

La Elletipi si riserva il diritto di effettuare modifiche ai propri prodotti senza obbligo di preavviso.

Catalogue's color are indicative.

Elletipi reserves the right to make modifications to its products without being obliged to give notice.

Los colores del catálogo son indicativos.

Elletipi se reserva el derecho de efectuar cambios en sus productos sin obligación alguna de previo aviso.

