



**CASA ITALIA**  
*door design*



**CASA ITALIA**  
*door design*

## L'AZIENDA - *Company profile*

MOBILCLAN nasce nel 1967 come produttore di frontali e componenti in legno per l'industria del mobile.

Dal 2015, MOBILCLAN produce anche frontali e componenti in MDF laccato a spruzzo, commercializzati con il brand MOBILLAC.

MOBILCLAN ha 2 stabilimenti produttivi

Legno: 31.000 m<sup>2</sup> coperti (65.000 m<sup>2</sup> totali)

MDF laccato: 15.000 m<sup>2</sup> coperti (54.000 m<sup>2</sup> totali).

Il personale impiegato da MOBILCLAN è di circa 300 persone.

A 50 anni dalla fondazione, i prodotti MOBILCLAN sono venduti in tutti i 5 continenti.

*MOBILCLAN was founded in 1967 to produce wooden frontals and components for the furniture industry.*

*Since 2015, MOBILCLAN has been producing also MDF painted frontals and components, sold under the brand name MOBILLAC.*

*MOBILCLAN runs 2 production units*

*Wood: 31.000 m<sup>2</sup> covered (65.000 m<sup>2</sup> total)*

*Painted MDF: 15.000 m<sup>2</sup> covered (54.000 m<sup>2</sup> total).*

*MOBILCLAN employs approx. 300 employees.*

*50 years after foundation, MOBILCLAN products are sold in all 5 continents.*

## LA NOSTRA FILOSOFIA - *Our philosophy*

Ascoltare, proporre, attuare: questa è la nostra filosofia. Per MOBILCLAN il cliente non va solamente soddisfatto, va anche stupito, con soluzioni estetiche e tecniche d'avanguardia oltre che industrialmente rigorose.

Il nostro sapere antico, la nostra curiosità, la nostra continua ricerca e sviluppo ci consentono di coniugare al meglio artigianalità ed elevata automazione.

*Listen, be proactive, achieve: this is our philosophy. Not only the Customer must be satisfied, he must also be amazed, with state-of-the-art solutions, both aesthetically and technically, besides industrial accuracy.*

*Our long-standing know how, our curiosity, our continuous research and development allow us to combine successfully craftsmanship and extensive automation.*





# QUALITÀ E SERVIZIO - *Quality and service*

MOBILCLAN è da sempre sinonimo di qualità. I nostri prodotti, seppure realizzati industrialmente, vengono curati nel minimo dettaglio sia nella fase di selezione delle materie prime, che in quella della realizzazione in grezzo, che in quella della finitura, che in quella dell'imballo. Siamo altresì conosciuti per la nostra proverbiale puntualità e completezza delle consegne. Infine, l'alto grado di informatizzazione aziendale ci consente tutti i tipi di collegamenti digitali personalizzati con i nostri Clienti.

*MOBILCLAN has always been synonymous of quality. Our products, though manufactured on an industrial basis, are taken care of in every single detail, throughout all manufacturing phases, from raw material selection, to production of raw products, to staining and lacquering - painting, to final packaging. We are also very well known for extremely high OTIF (On Time In Full) performances. Finally, MOBILCLAN high level Information Technology allows all types of personalized digital connections with our Customers.*

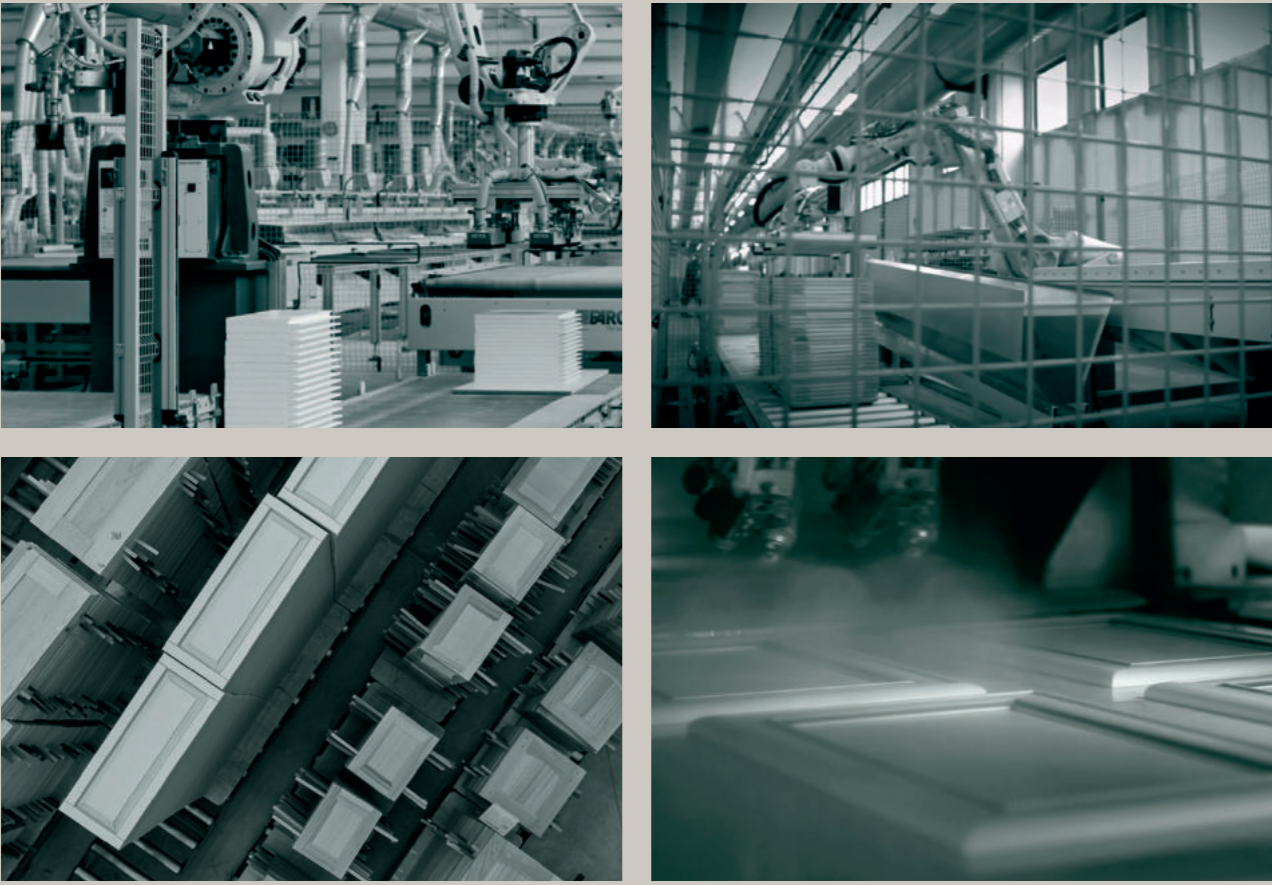

Richiedi i nostri prodotti certificati FSC® e i nostri prodotti certificati PEFC™. *Ask for our FSC® certified products and PEFC™ certified products.*



# MOBILCLAN INDUSTRIES

6



## C INDICE INDEX

RIALTO	<b>8</b> 9 10 11
TORINO	<b>12</b> 13 14 15
TRIESTE	<b>16</b> 17
VENEZIA	<b>18</b> 19
FIRENZE	<b>20</b> 21
POSITANO	<b>22</b> 23
SORRENTO	<b>24</b> 25
ISCHIA JIT	<b>26</b> 27 28 29 30 31
SCHEDE PRODOTTO PRODUCT SPECIFICATIONS	<b>32</b> 33 34 35 36 37 38 39 40 41 42 43 44 45
DOVE SIAMO WHERE WE ARE	<b>46</b>

7













12

TORINO

13













CORNICETTE VENEZIA  
CORNICES FOR VENICE MODEL

-  A
-  C
-  D
-  E

















FINITURA: 007 Bianco Anticato  
Argento / Just in time  
FINISH: 007 Bianco Anticato  
Argento / Just in time





FINITURA: 061 Dove Grey  
062 Petrolio / Just in time  
FINISH: 061 Dove Grey  
062 Petrolio / Just in time







063 Porcelain Decapé



064 Perla Decapé



007 Bianco Anticato Argento



056 Lino



061 Dove Grey



062 Petrolio



047 Nero



060 Shabby White



FINITURA: 064 Perla Decapé  
063 Porcelain Decapé / Just in time  
FINISH: 064 Perla Decapé  
063 Porcelain Decapé / Just in time



# GAMMA CLASSICA CLASSIC COLLECTION

Antine - Doors	896	746	596	446	396	377	296	240	146	100	50
1316		4									
956											
716		4									
596											
476											
356											
236		4									
Vetrine - Glassdoors											
1276				1							
956											
716											
476			3	3							
356											
Cassetti - Drawer fronts											
176											
116											
Riempitivi - Fillers											
956										5	5
716										5	5

## CURVI CURVED ITEMS

Terminale 315x315 - 315x315 End unit		
Vetrine - Glassdoors	956	
	716	
Antine - Doors		
	716	
Base curva 900x642 - Curved Base Unit 900x642		
Coppia ante curve - Curved doors (pair)	716	2
Base concava curva 900x900 - Internal Curved Base Unit 900x900		
Anta concava - Internal curved door	716	1
Pensile concavo curvo 600x600 - Internal Curved Wall Unit 600x600		
Anta concava - Internal curved door	716	1

**1** Solo modello Trieste  
Only model Trieste

**2** Solo modelli Venezia, Firenze, Trieste, Rialto  
Only models Venezia, Firenze, Trieste, Rialto

**3** Solo modello Rialto  
Only model Rialto

**4** Solo modelli Positano, Sorrento, Ischia JIT  
Only models Positano, Sorrento, Ischia JIT

**5** Solo modello Ischia JIT  
Only model Ischia JIT

# MODULARITÀ ALTEZZE KEY UNIT MEASUREMENTS

## CUCINE KITCHENS

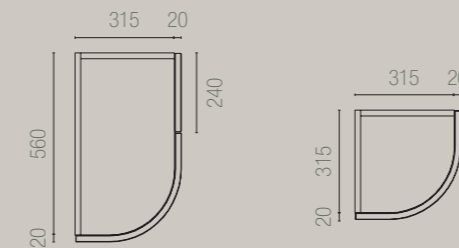
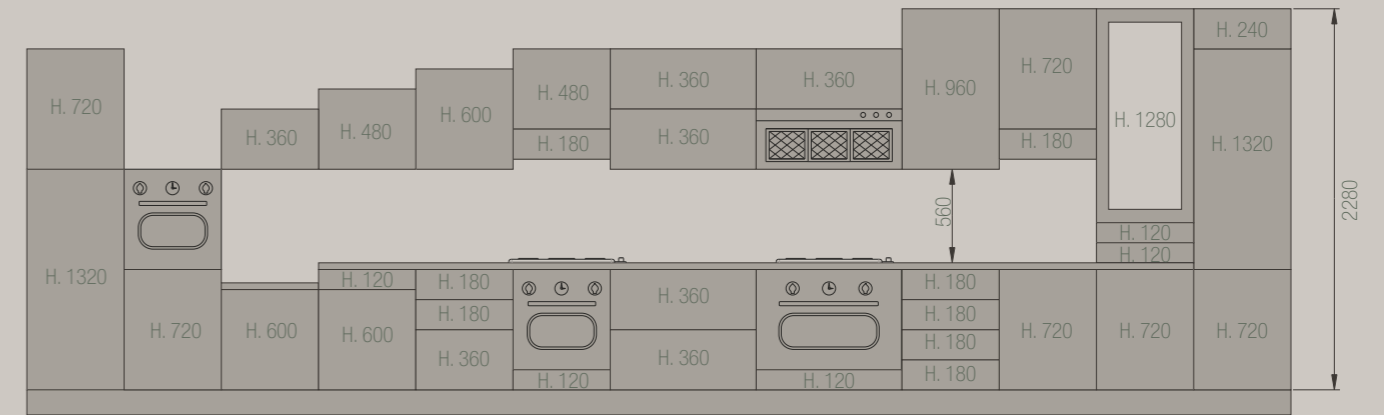

TERMINALI BASE E PENSILE  
BASE AND WALL UNITS

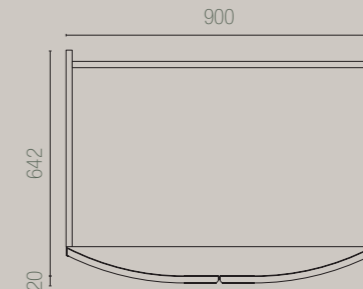

COPPIA ANTE CURVE  
CURVED DOOR (PAIR)

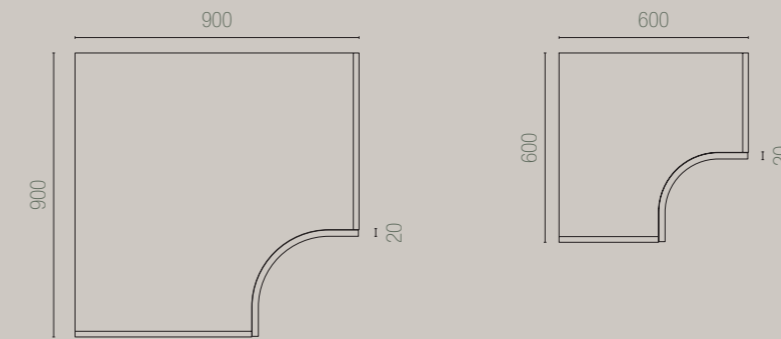

BASE CONCAVA CURVA 900 x 900 E PENSILE CONCAVO CURVO 600 x 600  
INTERNAL CURVED BASE AND WALL UNITS



# RIALTO ACCESSORI

ACCESSORIES

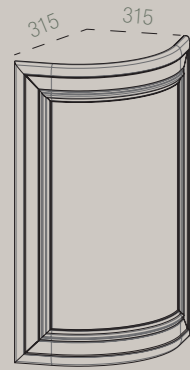

ANTINA CURVA  
CURVED DOOR  
"H" = 716

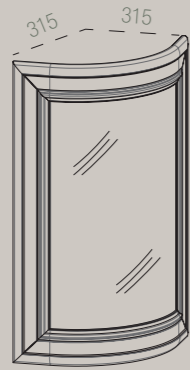

VETRINA CURVA  
CURVED GLASSDOOR  
"H" = 956 - 716

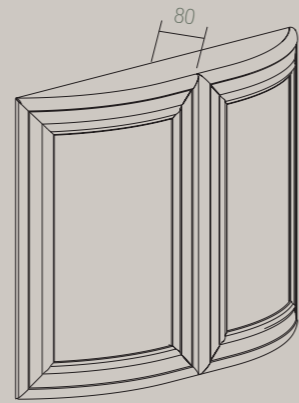

COPPIA ANTE CURVE  
CURVED DOOR (PAIR)  
716 x 446,5

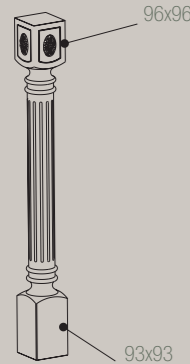

GAMBA ISOLA C/DECORO "H" = 870  
LEG FOR PENINSULA

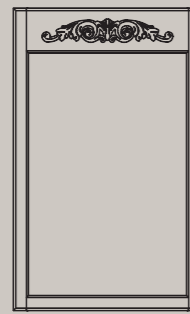

TELAIO  
OPEN FRAME  
716 x 446/596/896



GRIGLIA DISPONIBILE PER TUTTE LE VETRINE  
GRILLE AVAILABLE FOR ALL FRAME SIZES



DISTANZIALE LISCIO  
SIMPLE SPACER  
960/720 x 50 x 25



DISTANZIALE CON DECORO  
DECORATED SPACER  
960/720 x 50 x 40



DISTANZIALE CON DECORO  
PILASTER  
2280/960/720/480 x 100 x 54



ZOCCOLO  
PLINTH  
150 x 100 x 120

# RIALTO ACCESSORI

ACCESSORIES



SET CAPPA CAMINETTO  
MANTLE SET  
1040 x 1700 x 200

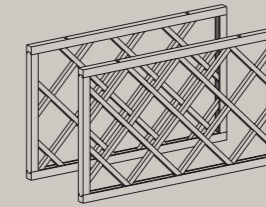

COPPIA GRIGLIA PORTABOTTIGLIE  
WINE RACK INSERT (PAIR)  
335 x 567 x 20



CORNICE COPRILUCE CURVO  
CURVED LIGHTING PELMET



CORNICE COPERCHIO CURVA  
CON DECORO  
CURVED CORNICE MOULDING WITH  
DECORATION



BALAUSTRÀ CURVA  
CURVED GALLERY RAIL

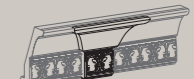

CAPITELLO PER CORNICE  
CORNICE MOULDING DECORATION  
50 x 107,2 - 100 x 107,2



CORNICE COPRILUCE  
LIGHTING PELMET  
3000 x 60 x 20



CORNICE COPERCHIO CON DECORO  
CORNICE MOULDING WITH DECORATION  
3000 x 132,5 x 30



BALAUSTRÀ  
GALLERY RAIL  
2000 x 86 x 18



CAPITELLO ANGOLO INTERNO  
INTERNAL CORNICE DECORATION  
133,1 x 133,1 x 107,2

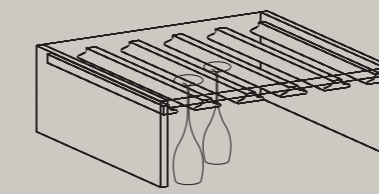

SET PORTABICCHIERI  
GLASS RACK RAIL  
500 x 20



CIMASA SAGOMATA  
FRIEZE RAIL  
900/600 x 90 x 20

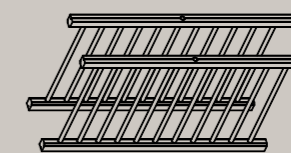

COPPIA GRIGLIE PORTAPIATTI  
PLATE RACK INSERT (PAIR)  
335 x 867/567

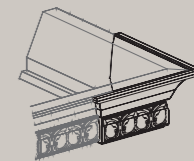

CAPITELLO ANGOLO ESTERNO  
EXTERNAL CORNICE DECORATION  
227,2 x 227,2 x 107,2



# TORINO ACCESSORI

ACCESSORIES

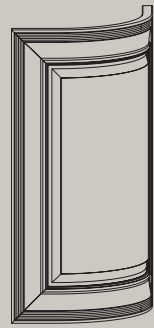

ANTINA CURVA  
CURVED DOOR  
"H" = 716



VETRINA CURVA  
CURVED GLASSDOOR  
"H" = 956 - 716



TELAIO A GIORNO  
OPEN FRAME  
716 x 896/596/446



TELAIO A GIORNO  
OPEN FRAME  
556 x 446

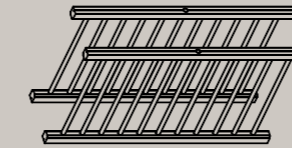

COPPIA GRIGLIE PORTAPIATTI  
PLATE RACK INSERT (PAIR)  
335 x 867/567

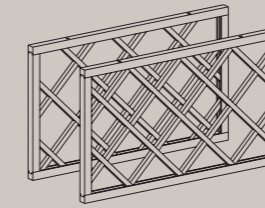

COPPIA GRIGLIE PORTABOTTIGLIE  
WINE RACK INSERT (PAIR)  
335 x 567 x 20

36



ANTINA CON COLONNINE  
DOOR WITH COLUMNS  
956/716 x 446



VETRINA CON GRATA  
FRAME WITH GRILLE  
716 x 446



GRIGLIA DISPONIBILE PER TUTTE LE VETRINE  
GRILLE AVAILABLE FOR ALL FRAME SIZES

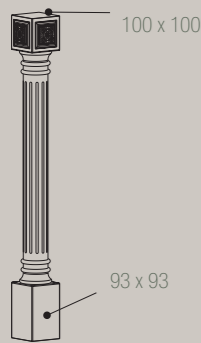

GAMBA ISOLA C/DECORO  
LEG FOR PENINSULA  
"H" = 870



DISTANZIALE  
PILASTER  
2280/960/720 x 75 x 30



MONTANTE ANGOLO  
CORNER POST  
720 x 40 x 40

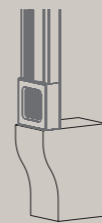

ZOCOLO  
PLINTH  
150 x 75 x 125



CORNICE COPRILUCE CURVO  
CURVED LIGHTING PELMET



CORNICE COPERCHIO CURVA  
CON DECORO  
CURVED CORNICE MOULDING WITH  
DECORATION



BALAUSTRÀ CURVA  
CURVED GALLERY RAIL



CORNICE COPRILUCE  
LIGHTING PELMET  
3000 x 60 x 20

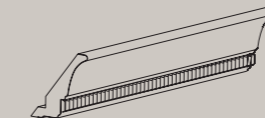

CORNICE COPERCHIO CON DECORO  
CORNICE MOULDING WITH DECORATION  
3000 x 119,6 x 30

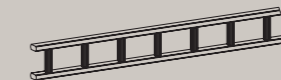

BALAUSTRÀ  
GALLERY RAIL  
2000 x 80 x 26

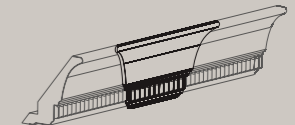

CAPITELLO PER CORNICE  
CORNICE MOULDING DECORATION  
170 x 84,4 x 59,5

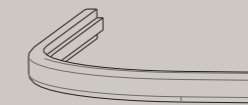

BORDO TOP CURVO  
CURVED WORKTOP EDGE



CIMASA SAGOMATA  
FRIEZE RAIL  
900/600/450 x 110 x 24

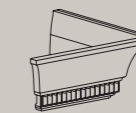

CAPITELLO ANGOLO ESTERNO  
EXTERNAL CORNICE DECORATION  
204,4 x 204,4 x 84,4

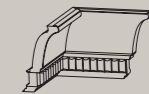

CAPITELLO ANGOLO INTERNO  
INTERNAL CORNICE DECORATION  
134,5 x 134,5 x 84,4

37



# TRIESTE ACCESSORI

ACCESSORIES

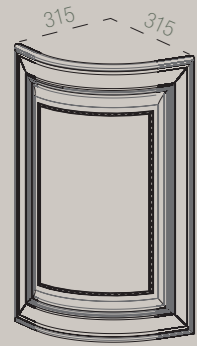

ANTINA CURVA  
CURVED DOOR  
"H" = 716

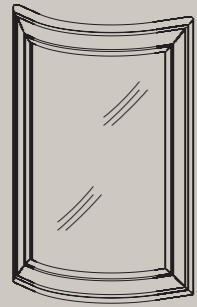

VETRINA CURVA  
CURVED GLASSDOOR  
"H" = 956 - 716



ANTINA BASE CONCAVA  
CURVED DOOR  
"H" = 716



ANTINA PENSILE CONCAVA  
CURVED DOOR  
"H" = 956 - 716

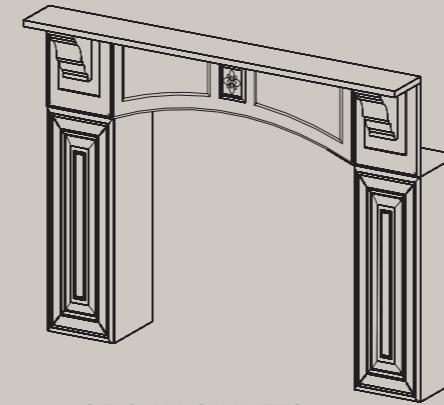

SET CAPPA CAMINETTO  
MANTLE SET  
1040 x 1700 x 205



CIMASA SAGOMATA  
FRIEZE RAIL  
900/600/450 x 87 x 20



PORTABOTTIGLIE  
BOTTLE RAIL  
600/450 x 60 x 20



BALAUSTRATA  
GALLERY RAIL  
2000 x 86 x 18



BALAUSTRATA CURVA  
CURVED GALLERY RAIL

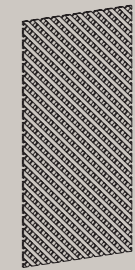

GRIGLIA DISPONIBILE PER  
TUTTE LE VETRINE  
GRILLED AVAILABLE FOR  
ALL FRAME SIZES

88

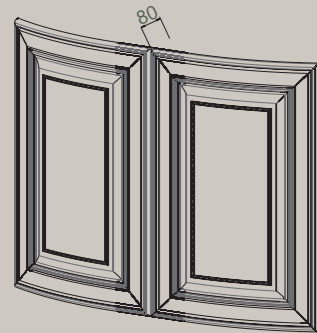

COPPIA ANTE CURVE  
CURVED DOOR (PAIR)  
716 x 446,5



ZOCCOLO PER DISTANZIALE  
PLINTH FOR PILASTER  
150 x 75 x 120

DISTANZIALE CON MOSAICO  
SPACER  
2280/2040/960/720 x 75 x 32

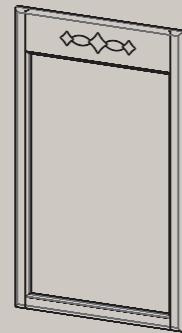

TELAIO  
OPEN FRAME  
716 x 446/596/896

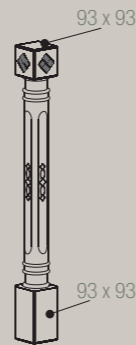

GAMBA ISOLA CON DECORO  
LEG FOR PENINSULA  
"H" = 870

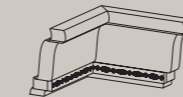

CAPITELLO CORNICE ANGOLO  
INTERNO  
INTERNAL CORNICE DECORATION  
141 x 141 x 75,9

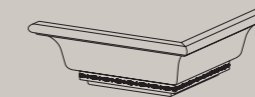

CAPITELLO CORNICE ANGOLO ESTERNO  
EXTERNAL CORNICE DECORATION  
208 x 208 x 75,9

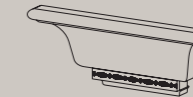

CAPITELLO CORNICE COPERCHIO  
CORNICE MOULDING DECORATION  
179 x 75,9 x 66

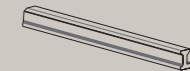

CORNICE SOTTOCAPPELLO  
LOWER CORNICE PROFILE  
3000 x 50 x 40

88

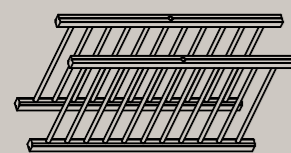

COPPIA GRIGLIE PORTAPIATTI  
PLATE RACK INSERT (PAIR)  
335 x 867

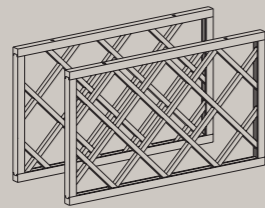

COPPIA GRIGLIE PORTABOTTIGLIE  
WINE RACK INSERT (PAIR)  
335 x 567

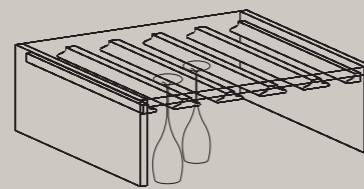

SET PORTABICCHIERI  
GLASS RACK RAIL  
500 x 20

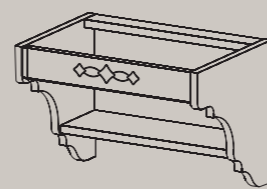

SOTTOPENSILE  
MIDWAY UNIT  
315 x 900 x 315 - 315 x 450 x 315



CORNICE COPRILUCE  
LIGHTING PELMET  
3000 x 60 x 20



SOTTOCAPPELLO CURVA  
LOWER CURVED CORNICE PROFILE



CORNICE COPRILUCE CURVO  
CURVED LIGHTING PELMET



SOTTOCAPPELLO CONCAVA  
INTERNAL LOWER CURVED  
CORNICE PROFILE



CORNICE COPRILUCE CONCAVA  
INTERNAL CURVED LIGHTING PELMET



CORNICE COPERCHIO  
CORNICE MOULDING  
3000 x 110 x 30



CORNICE COPERCHIO CURVA  
CURVED CORNICE MOULDING

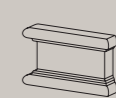

CAPITELLO SOTTOCORNICE  
LOWER CORNICE PROFILE  
84 x 50 x 23



# VENEZIA - FIRENZE ACCESSORI

ACCESSORIES

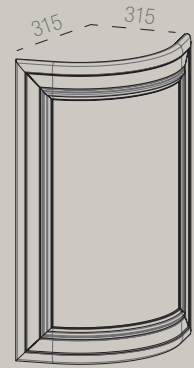

ANTINA CURVA  
CURVED DOOR  
"H" = 716

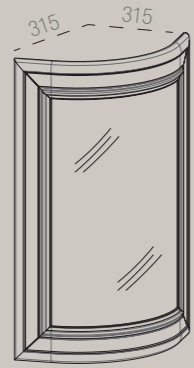

VETRINA CURVA  
CURVED GLASSDOOR  
"H" = 956 - 716

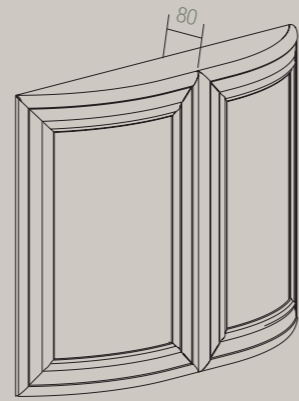

COPPIA ANTE CURVE  
CURVED DOOR (PAIR)  
716 x 446,5

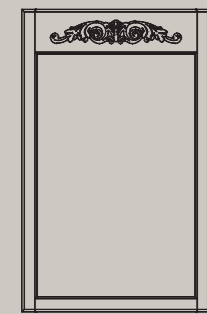

TELAIO  
OPEN FRAME  
716 x 446/596/896



GRIGLIA DISPONIBILE PER TUTTE LE  
VETRINE  
GRILLE AVAILABLE FOR ALL FRAME SIZES



DISTANZIALE LISCIO  
SIMPLE SPACER  
960/720 x 50 x 25



DISTANZIALE CON DECORO  
DECORATED SPACER  
960/720 x 50 x 40



DISTANZIALE  
PILASTER  
2280/960/720 x 100 x 55

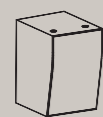

ZOCCOLO  
PLINTH  
150 x 100 x 120

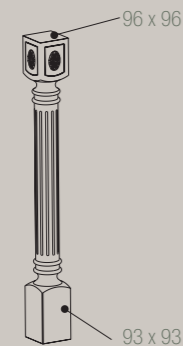

GAMBA ISOLA CON DECORO  
LEG FOR PENINSULA  
"H" = 870

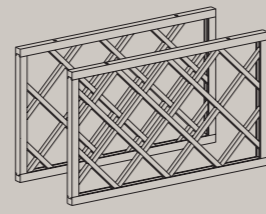

COPPIA GRIGLIE PORTABOTTIGLIE  
WINE RACK INSERT (PAIR)  
335 x 567

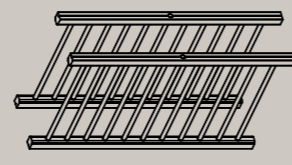

COPPIA GRIGLIE PORTAPIATTI  
PLATE RACK INSERT (PAIR)  
335 x 867/567

# VENEZIA - FIRENZE ACCESSORI

ACCESSORIES



CAPITELLO ANGOLO INTERNO  
INTERNAL CORNICE DECORATION  
131,1 x 133,1 x 107,2



CORNICE COPERCHIO CURVA CON  
DECORO  
CURVED CORNICE MOULDING WITH  
DECORATION



CORNICE COPERCHIO CON  
DECORO  
CORNICE MOULDING WITH  
DECORATION  
3000 x 132,5 x 30

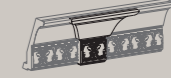

CAPITELLO PER CORNICE  
CORNICE MOULDING DECORATION  
50 x 107,2 - 100 x 107,2

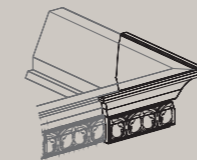

CAPITELLO ANGOLO ESTERNO  
EXTERNAL CORNICE DECORATION  
227,2 x 227,2 x 107,2



CORNICE COPRILUCE CURVO  
CURVED LIGHTING PELMET



CORNICE COPERCHIO CURVA  
CON RIPORTO  
CURVED CORNICE MOULDING  
WITH DECORATION



BALAUSTRÀ CURVA  
CURVED GALLERY RAIL



BALAUSTRÀ  
GALLERY RAIL  
2000 x 72 x 26



CORNICE COPRILUCE  
LIGHTING PELMET  
3000 x 60 x 20



CORNICE COPERCHIO CON RIPORTO  
CORNICE MOULDING WITH DECORATION  
3000 x 110 x 30



CIMASA SAGOMATA  
FRIEZE RAIL  
900/600/450 x 90 x 20



PORTABOTTIGLIE  
BOTTLE RAIL  
450 x 60 x 20

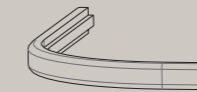

BORDO TOP CURVO  
CURVED WORKTOP EDGE

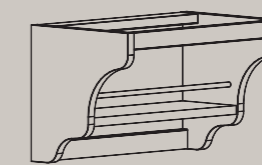

SOTTOPENSILE  
MIDWAY UNIT  
280 x 450 x 280

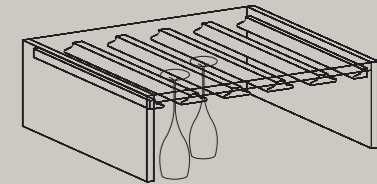

SET PORTABICCHIERI  
GLASS RACK RAIL  
500 x 20



# POSITANO - SORRENTO - ISCHIA JIT

ACCESSORIES

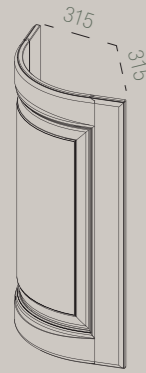

ANTINA CURVA  
CURVED DOOR  
"H" = 716

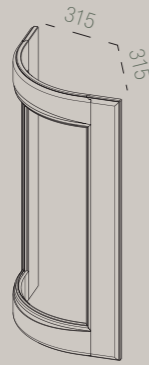

VETRINA CURVA  
CURVED GLASSDOOR  
"H" = 956 - 716

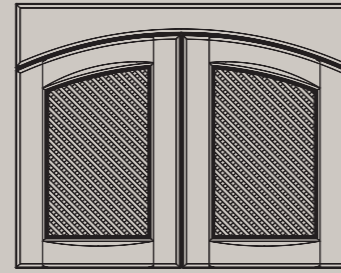

SET ANTINE CON GRIGLIA  
DOOR WITH GRILLE/FRIEZE (PAIR)  
716 x 896

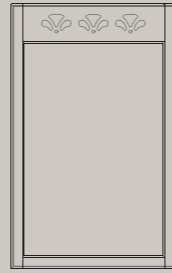

TELAIO  
OPEN FRAME  
716 x 446/596/896

# POSITANO - SORRENTO - ISCHIA JIT

ACCESSORIES

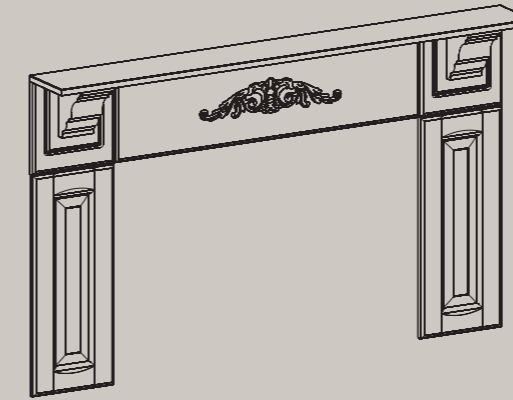

SET CAPPA CAMINETTO  
MANTLE SET  
1040 x 1700 x 200



FIANCO A FINIRE  
END PANEL  
2430/870 x 580 x 18  
960 x 335 x 18

42



TELAIO PORTABOTTIGLIE  
WINE RACK FRAME  
716 x 146

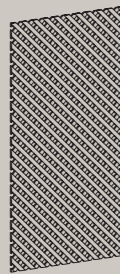

GRIGLIA DISPONIBILE PER TUTTE  
LE VETRINE  
GRILLE AVAILABLE FOR ALL  
FRAME SIZES

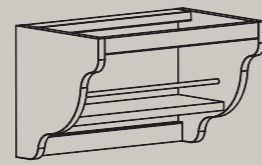

SOTTOPENSILE  
MIDWAY UNIT  
280 x 450 x 280



DISTANZIALE LISCIO  
SIMPLE SPACER  
960/720 x 50 x 25

43



CORNICE COPRILUCE CURVO  
CURVED LIGHTING PELMET



CORNICE COPERCHIO CURVA  
CON RIPORTO  
CURVED CORNICE MOULDING  
WITH DECORATION



BORDO TOP CURVO  
CURVED WORKTOP EDGE



CORNICE COPRILUCE  
LIGHTING PELMET  
3000 x 60 x 20



DISTANZIALE RIGATO  
DECORATED SPACER  
960/720 x 50 x 40



DISTANZIALE  
PILASTER  
2280/960/720 x 100 x 44

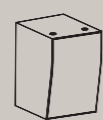

ZOCCOLO  
PLINTH  
150 x 100 x 120

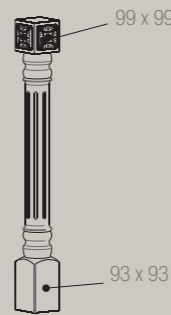

GAMBA ISOLA CON DECORO  
LEG FOR PENINSULA  
"H" = 870

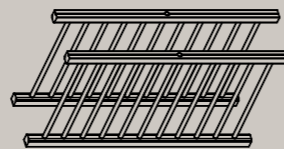

COPPIA GRIGLIE PORTAPIATTI  
PLATE RACK INSERT (PAIR)  
335 x 867/567



CORNICE COPERCHIO CON RIPORTO  
CORNICE MOULDING WITH DECORATION  
3000 x 110 x 30



CORNICE COPERCHIO  
CORNICE MOULDING  
2400 x 97,4 x 35



CIMASA SAGOMATA  
FRIEZE RAIL  
900/600/450 x 90 x 20

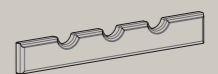

PORTABOTTIGLIE  
BOTTLE RAIL  
450 x 60 x 20



BALAUSTRÀ CURVA  
CURVED GALLERY RAIL

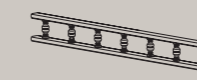

BALAUSTRÀ  
GALLERY RAIL  
2000 x 72 x 26

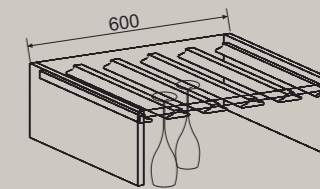

SET PORTABICCHIERI  
GLASS RACK RAIL  
500 x 20



# LINEA CLASSICA

CLASSIC COLLECTION



Rialto

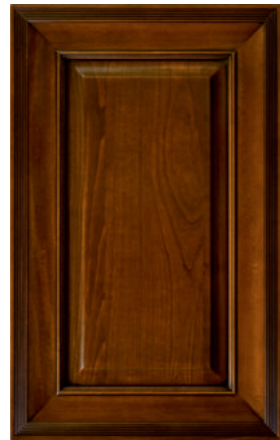

Torino



Trieste



Venezia



Firenze



Positano



Sorrento

# ISCHIA JIT

ISCHIA JIT



Anta disponibile a magazzino in legno non finito da personalizzare.  
*Unfinished door available ex-stock, ready to be custom finished just in time.*

FINITURE PORO APERTO DISPONIBILI PER FORNITURE JUST IN TIME.  
*OPEN PORE PAINTED FINISHES, AVAILABLE FOR JUST IN TIME SUPPLIES.*



063 Porcelain Decapé



064 Perla Decapé



007 Bianco Anticato Argento



056 Lino



061 Dove Grey



062 Petrolio



047 Nero



060 Shabby White



**DA VENEZIA / DA TREVISO**

Aeroporto Marco Polo a Tessera-Venezia / Aeroporto di Treviso

Prendete la A27 fino a Conegliano, poi la A28 in direzione Portogruaro fino all'uscita Sacile Ovest.

All'uscita svoltate a destra in direzione Gaiarine/Francenigo ed alla rotonda prendete la 1° uscita in direzione Gaiarine/Francenigo.

Continuate sulla SP44 tenendo la destra per ca. 4 km fino a Calderano, dove sulla destra troverete il cartello Welcome to Mobilclan, svoltate in Via Bruna e ci troverete sulla destra dopo ca. 100 metri.

**DA TRIESTE**

Aeroporto Ronchi dei Legionari – Trieste

Prendete la A4 in direzione Venezia, fino a Portogruaro.

Proseguite sulla A28 in direzione Pordenone/Conegliano, fino all' uscita Sacile Ovest dell'autostrada.

All'uscita svoltate a sinistra in direzione Gaiarine/Francenigo ed alla rotonda prendete la 1° uscita in direzione Gaiarine/Francenigo.

Continuate sulla SP44 tenendo la destra per ca. 4 km fino a Calderano, dove sulla destra troverete il cartello Welcome to Mobilclan, svoltate in Via Bruna e ci troverete sulla destra dopo ca. 100 metri.

**FROM VENICE / FROM TREVISO**

*Airport Marco Polo in Tessera–Venice / Airport Treviso*

*Take motorway A27 to Conegliano Veneto, then A28 direction Portogruaro up to Sacile Ovest.*

*Leave the motorway in Sacile Ovest, turn right direction Gaiarine/Francenigo.*

*At the roundabout keep right direction Gaiarine/Francenigo.*

*Continue on Sp44 keeping right for about 4 km until you reach Calderano where on the right side of the road you will see a board “Welcome to Mobilclan”, take Via Bruna and we are on the right after just 100 metres.*

**FROM TRIESTE**

*Airport Ronchi dei Legionari – Trieste*

*Take motorway A4 direction Venice up to Protoguraro.*

*Continue on A28 direction Pordenone/Conegliano. Leave the motorway in Sacile Ovest, turn left direction Gaiarine/Francenigo.*

*At the roundabout keep right direction Gaiarine/Francenigo.*

*Continue on Sp44 keeping right for about 4 km until you reach Calderano where on the right side of the road you will see a board “Welcome to Mobilclan”, take Via Bruna and we are on the right after just 100 metres.*







**CASA ITALIA**  
*door design*

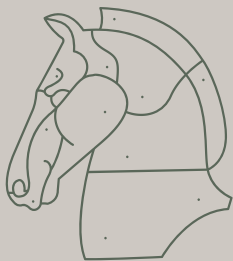

**MOBILCLAN SPA**

Via Bruna, 23

31018 Calderano di Gaiarine (TV) - Italia

Tel. +39 0434 766911 Fax +39 0434 767856

sales@mobilclan.com - www.mobilclan.com