

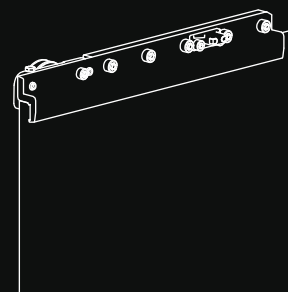

NEW

Micro 50

Concealed slides integrated into profiles with reduced dimensions
Scorrevoli invisibili integrati in profili di scorrimento di dimensioni ridotte





Micro 50

Concealed sliding elements integrated into profiles with reduced dimensions (50 mm)

Scorrevoli invisibili integrati in profili di scorrimento di dimensioni ridotte (50 mm)



EN

CONCEALED sliding elements integrated into aluminium profiles with reduced dimensions (50 mm). No need for holes or drilling on the glass

IT

Sistema di scorrevoli **INVISIBILI** integrati in profili di scorrimento in alluminio di dimensioni ridotte (50 mm). Non occorrono lavorazioni sul vetro

FR

Système de coulisses **INVISIBLES** intégrées dans les profils de glissement en aluminium avec des dimensions réduites (50 mm). Pas besoin de trous ou de forage sur le verre

DE

NICHT SICHTBARE Schiebeseysteme, die in die Schiebepprofile aus Aluminium integriert wurden mit geringen Abmessungen (50 mm). Keine Notwendigkeit für Löcher oder Bohrungen auf dem Glas

ES

Sistema de correderas **INVISIBLES** integradas en los perfiles de deslizamiento de aluminio con dimensiones reducidas (50 mm). No hay necesidad de agujeros o perforaciones en el cristal





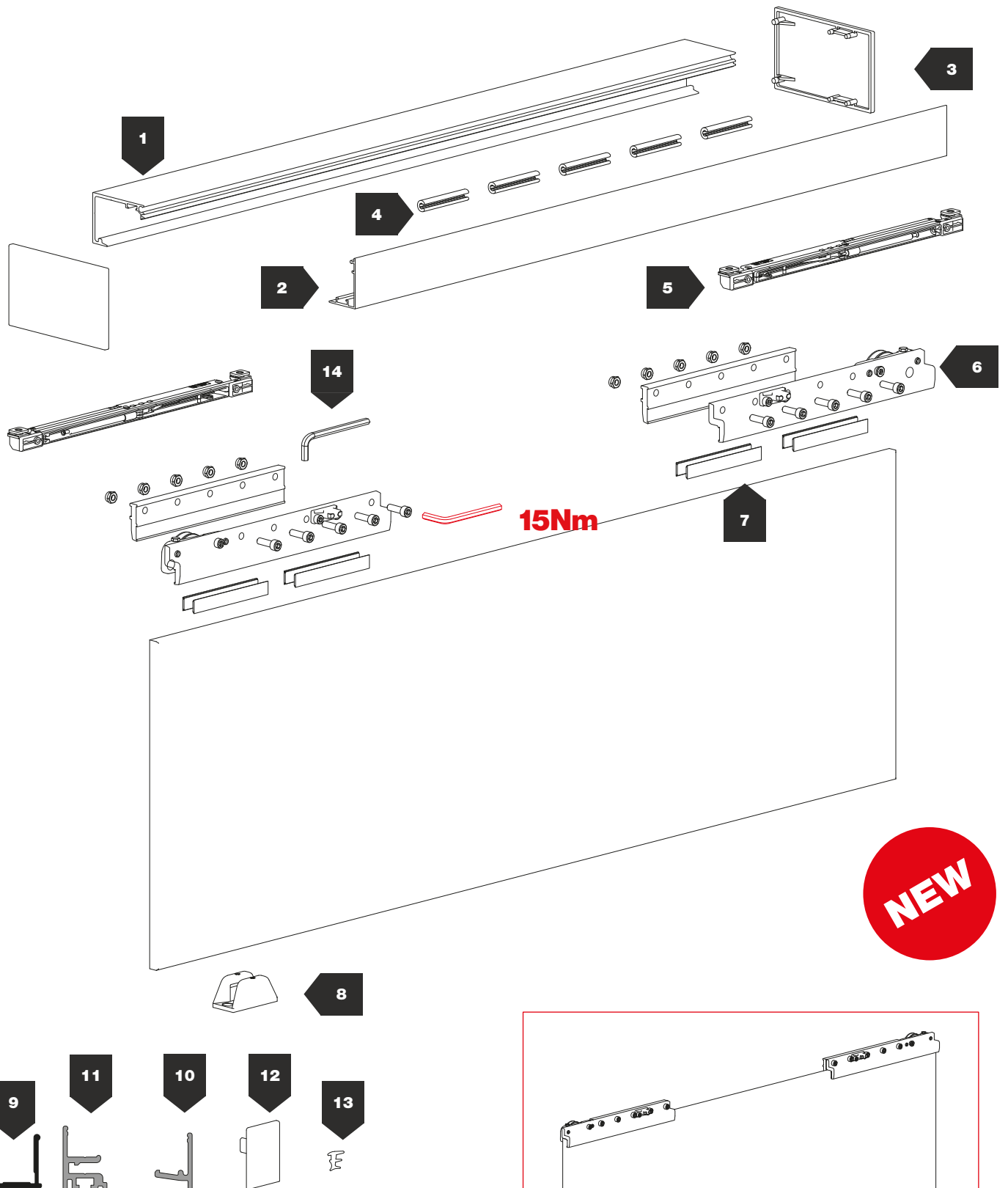







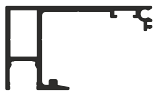

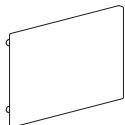
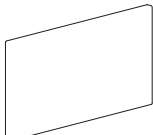

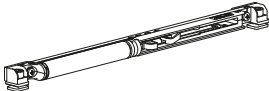
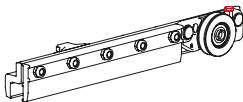



NEW

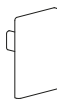

8 mm ÷ 12 mm



80 Kg

N°	Barcode		KG	
1	2450		80	
	2460		80	
2	2470		80	
3	2456		80	
	2466		80	
4	1222		80	
5	2604		80	
6	2454		80	
7	1707		80	For glass Per vetri 8-8,7 mm (5/16")
	1704		80	For glass Per vetri 10-10,7 mm (3/8")
	1705		80	For glass Per vetri 12-12,7 mm (1/2")
8	1488		80	
9	2740		80	
10	1776		80	
11	1775			
12	1794		80	
13	328		80	For glass Per vetri 8-8,7 mm (5/16")
	326		80	For glass Per vetri 10-10,7 mm (3/8")
	324		80	For glass Per vetri 12-12,7 mm (1/2")
14	409			
	538			

CODE	KG	KIT	
2454/2604	80		

ALUMINIUM TRACKS / BINARI IN ALLUMINIO

ART. 2450	ART. 2460	ART. 2470

ART. 1775	ART. 1776	ART. 2740	ART. 328 (8/8,7mm - 5/16")	ART. 326 (10/10,7 mm - 3/8")	ART. 324 (12/12,7 mm - 1/2")

LOWER GUIDES / GUIDE INFERIORI

ART. 1489	

SIZE DESCRIPTION / DESCRIZIONE MISURE

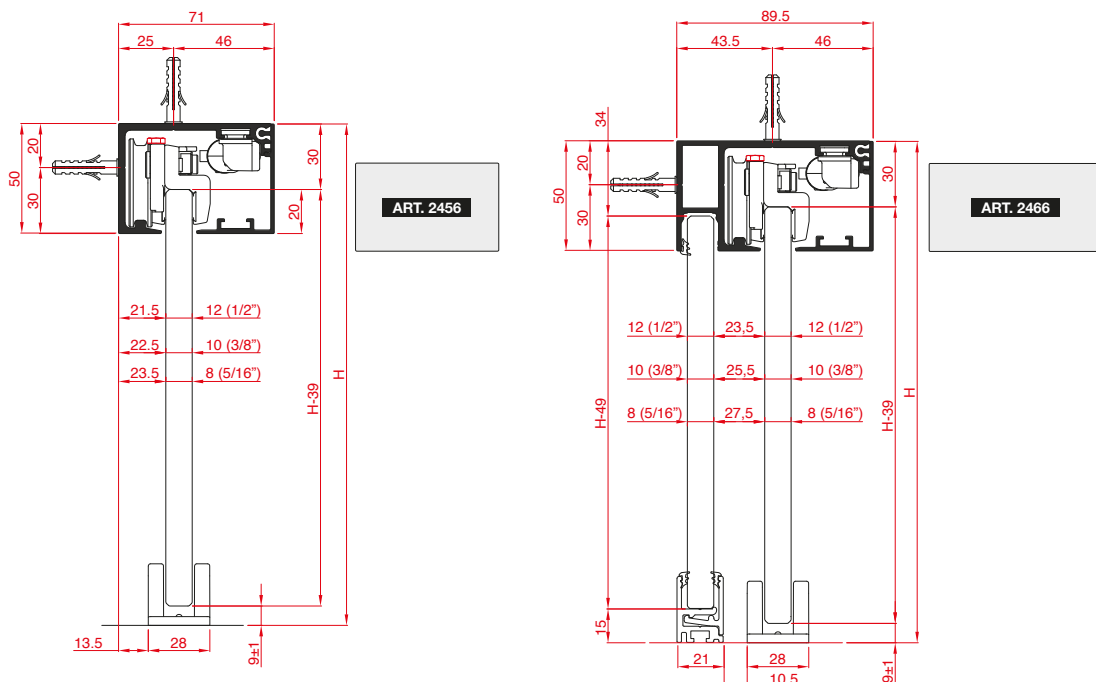

EASY TO MOUNTING / FACILE DA MONTARE

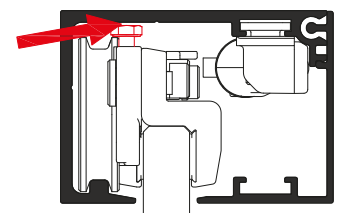
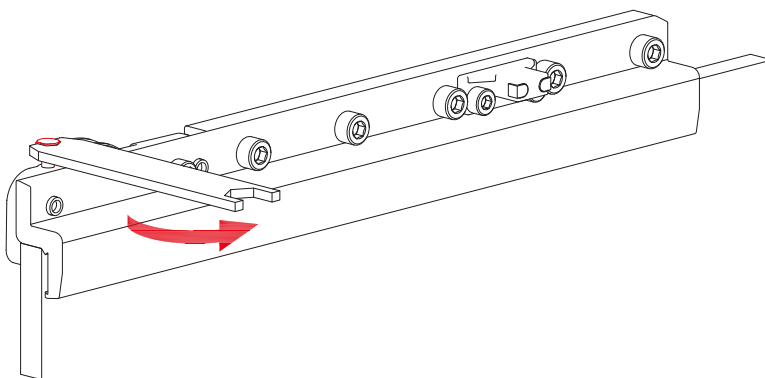
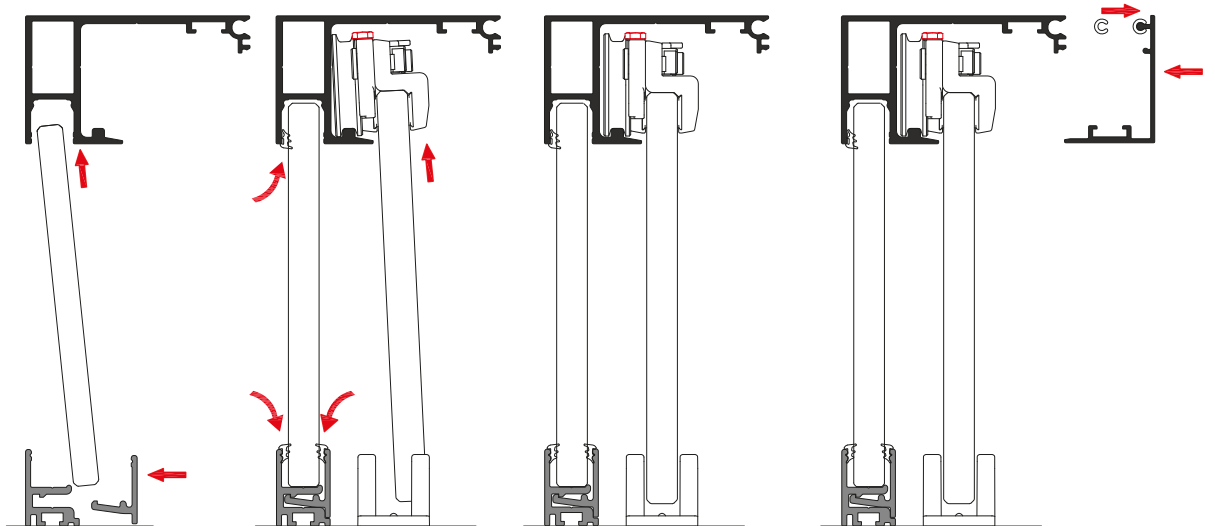
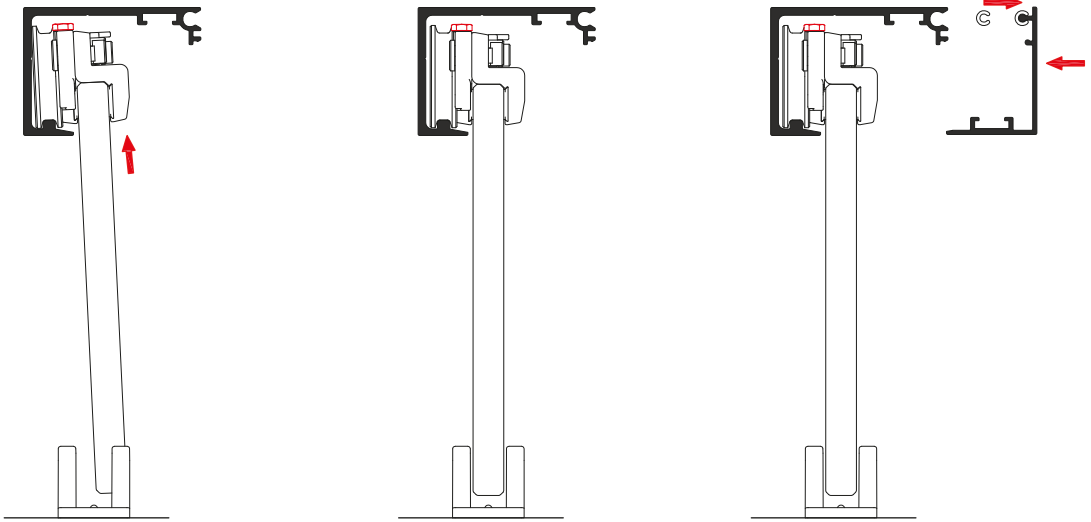



www.ternoscorrevoli.com/micro-50