

Unico

by ambigence

Meccanismo di apertura con cerniera integrata
Opening mechanism with integrated hinge



Meccanismo di apertura con cerniera integrata

Opening mechanism with integrated hinge



Unico è un meccanismo per ante a ribalta con cerniera integrata. Ha uno spessore di soli 12 mm (13,5 mm con cover).

È disponibile per tre tipi di applicazione:

- montaggio esterno con cover
- montaggio incassato in controspalla
- montaggio a filo con cover

Per ante con spessore da 18 mm. La posizione dell'anta è regolabile nelle tre dimensioni. Apertura e chiusura ottimizzabili grazie alla regolazione della forza della molla.

Materiali: acciaio, zama, tecnopolimero.

Colori cover: bianco segnale (RAL 9003), grigio seta (RAL 7044), grigio quarzo (RAL 7039), grigio ferro (RAL 7011), marrone grigiastro (RAL 8019), nero traffico (RAL 9017).

Unico is a mechanism for downward flap doors with integrated hinge. It is just 12 mm thick (13,5 mm with the cover).

It is available for three types of applications:

- external mounting with cover
- recessed mounting in cover side panel
- recessed flush mounting with cover

You can mount doors with thickness from 18 mm. The position of the door is adjustable in the 3 dimensions. Opening and closing can be optimized thanks to the adjustment of the spring force.

Materials: steel, zama, technopolymer.

Cover colors: white signal (RAL 9003), silk grey (RAL 7044), quartz grey (RAL 7039), iron grey (RAL 7011) greyish brown (RAL 8019), black traffic (RAL 9017).

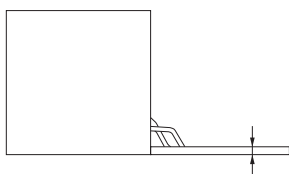

Spessore anta da 18 a 20 mm
Door's thickness from 18 to 20 mm

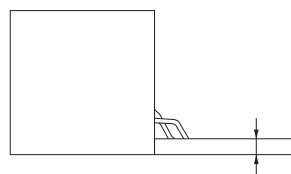

Spessore anta da 22 a 30 mm
Door's thickness from 22 to 30 mm

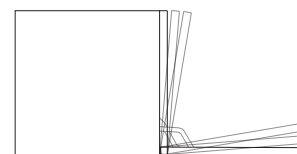

Apertura e chiusura ammortizzate
Soft opening and soft closing

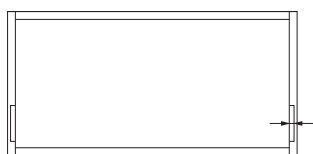

Spessore meccanismo ridotto
Narrow mechanism's thickness

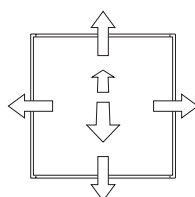

Regolazione orizzontale, verticale e frontale
Horizontal, vertical and frontal adjustment

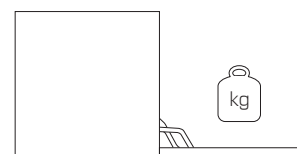

Regolazione forza della molla
Spring's force adjustment



Finiture meccanismo Mechanism's finishing



Colori standard cover (RAL) Cover's standard colors (RAL)

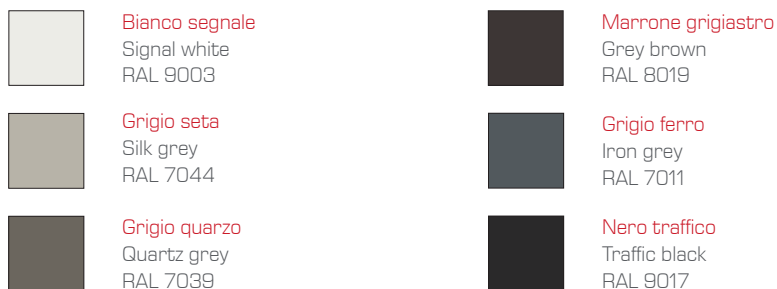

Per informazioni riguardanti quantità minime ordinabili e colori personalizzati rivolgersi a: info@effegibrevetti.com.
For information about minimum order quantities and custom colors please contact: info@effegibrevetti.com.

Tipologie meccanismo Mechanisms types

Spessori standard Standard thickness

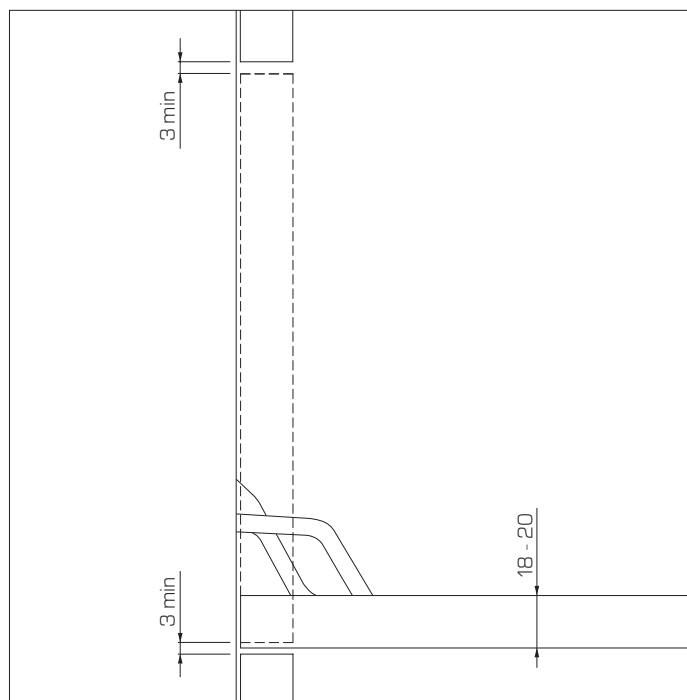

Grandi spessori Large thicknesses

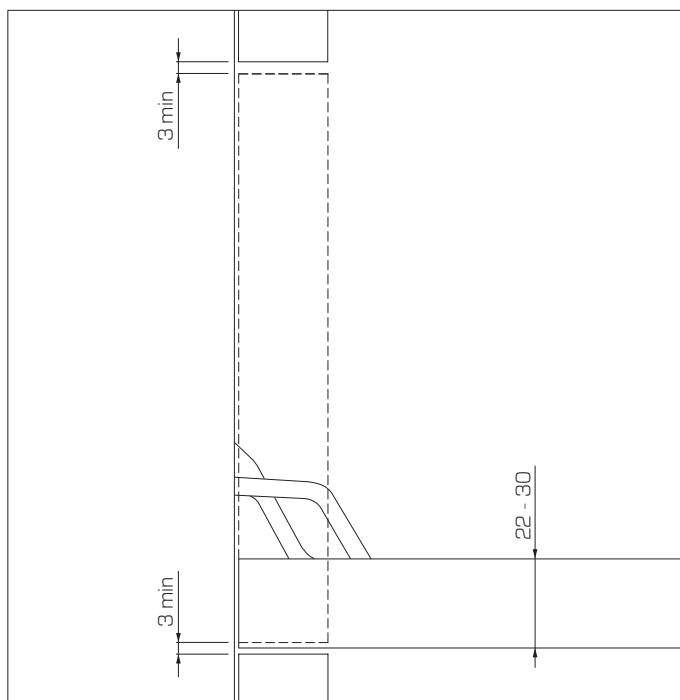

ATTENZIONE WARNING

Il peso e la posizione della maniglia possono influenzare le prestazioni del meccanismo.
The weight and the position of the handle may influence the performance of the mechanism.



Montaggio esterno con cover
External mounting with cover

$$D = S + 1$$



Montaggio incassato in controspalla
Recessed mounting in cover side panel

$$D = S + 1$$



Montaggio esterno con cover a filo
External mounting with flush cover

$$D = S - 13,5$$

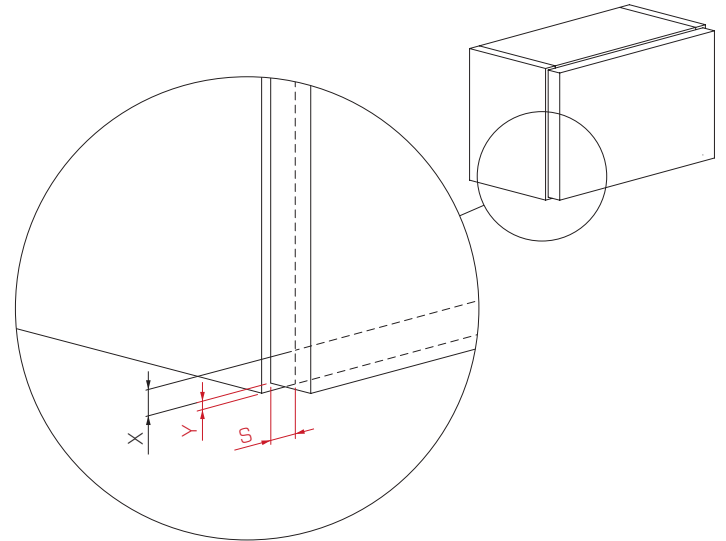
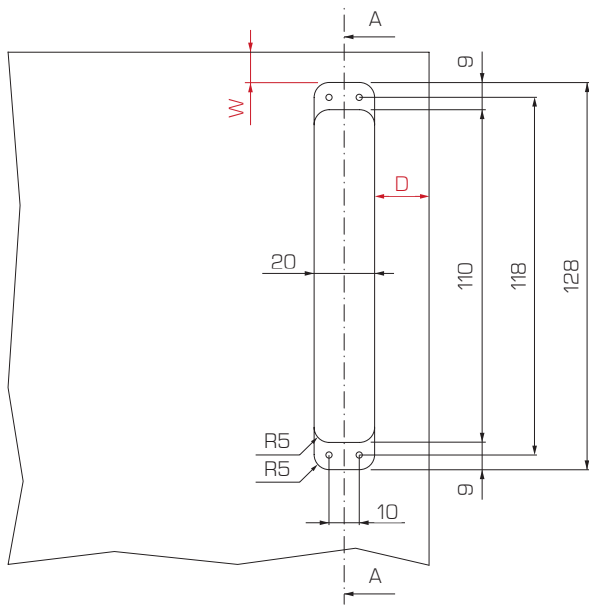

Spessori standard
Standard thickness

Grandi spessori
Large thicknesses

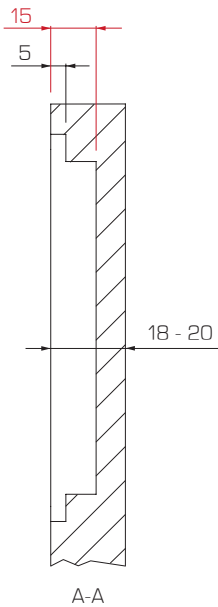

Y	W
1	11
1,5	10,5
2	10
2,5	9,5
3	9
4	8
5	7

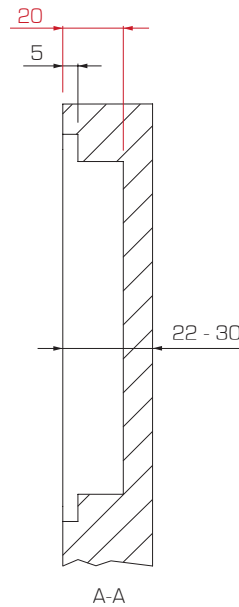

Y	W
1	16
1,5	15,5
2	15
2,5	14,5
3	14
4	13
5	12

Lavorazioni spalla (montaggio esterno con cover e montaggio incassato in contropalla)

Side panel's workings (external mounting with cover and recessed mounting in cover side panel)



Montaggio esterno con cover
External mounting with cover



Montaggio incassato in contropalla
Recessed mounting in cover side panel

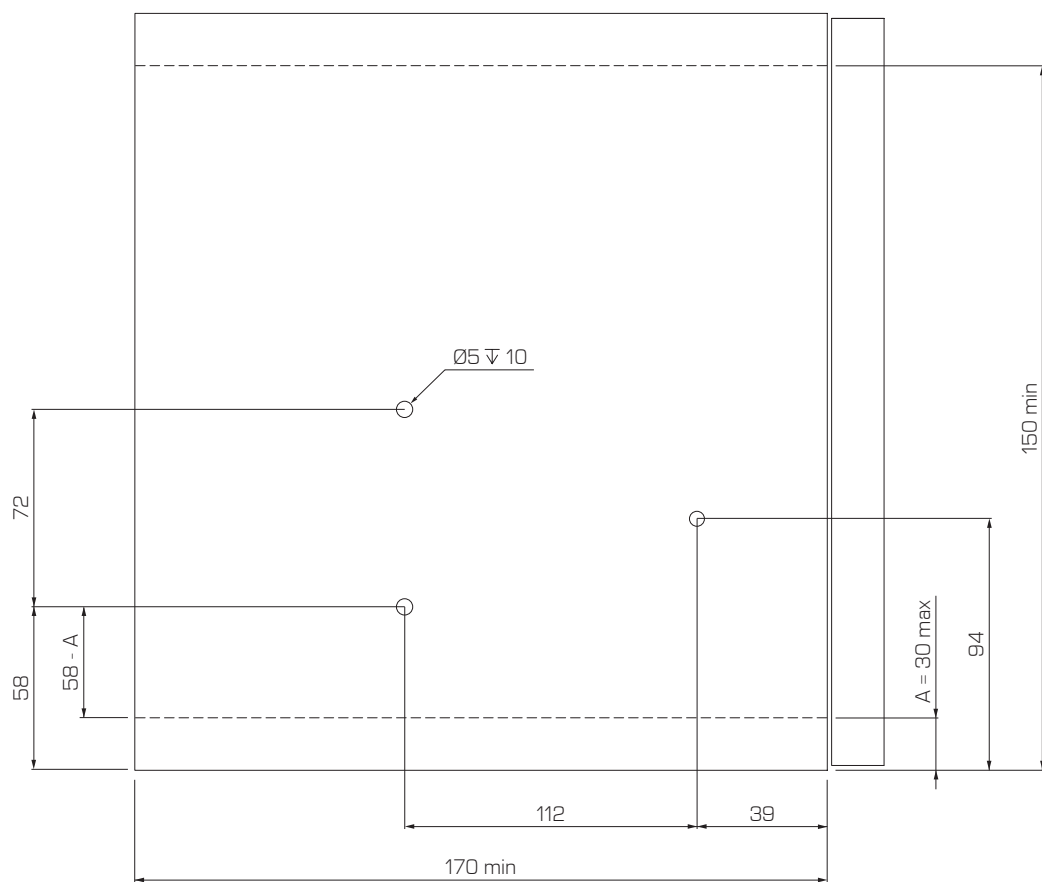

Lavorazioni controspalla (montaggio incassato in controspalla)
Cover side panel's workings (recessed mounting in cover side panel)



Montaggio incassato in controspalla
Recessed mounting in cover side panel

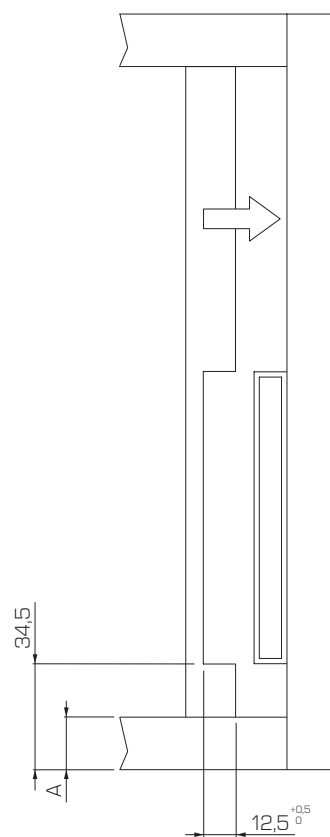
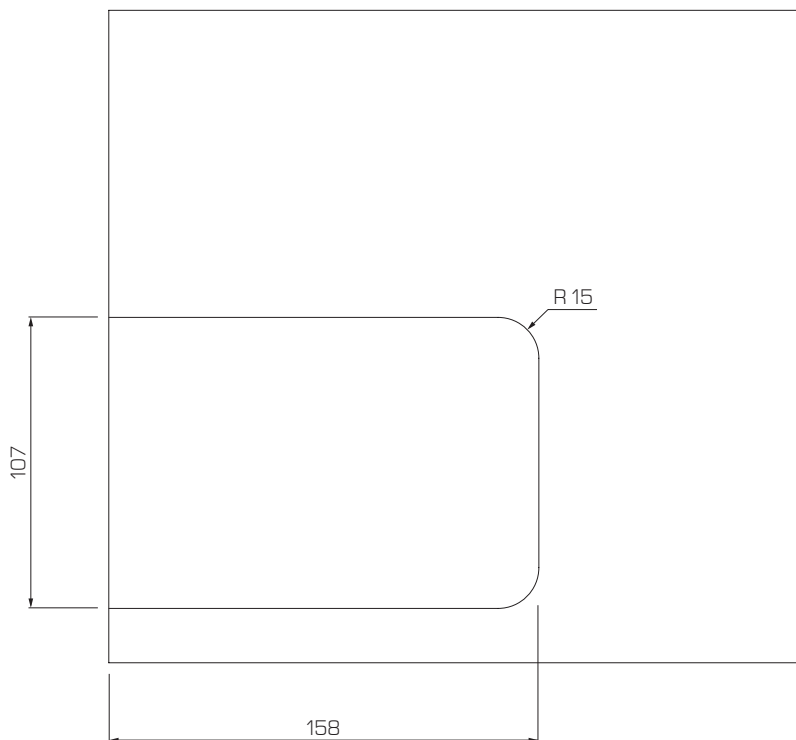

Foratura spalla (montaggio esterno con cover a filo)
Side panel drilling (external mounting with flush cover)



Montaggio esterno con cover a filo
External mounting with flush cover



Tabella pesi anta (kg)
Door weight tables (kg)



Hp	Config. 1	Config. 2	Config. 3	Config. 4	Config. 5	Config. 6
180 - 230	3,0 - 4,7	4,8 - 6,7	6,8 - 8,5	-	-	-
230 - 270	2,5 - 3,7	3,8 - 5,5	5,6 - 7,5	7,6 - 10,0	-	-
270 - 330	2,0 - 3,4	3,5 - 4,9	5,0 - 6,4	6,5 - 9,4	9,5 - 10,5	-
330 - 380	2,0 - 2,8	2,9 - 4,2	4,3 - 5,5	5,6 - 7,6	7,7 - 10,0	10,1 - 12,5
380 - 430	-	2,5 - 3,6	3,7 - 4,7	4,8 - 6,9	7,0 - 8,3	8,4 - 11,5
430 - 480	-	2,0 - 2,9	3,0 - 4,0	4,1 - 6,0	6,1 - 7,9	8,0 - 10,5

Imballaggio
Packaging

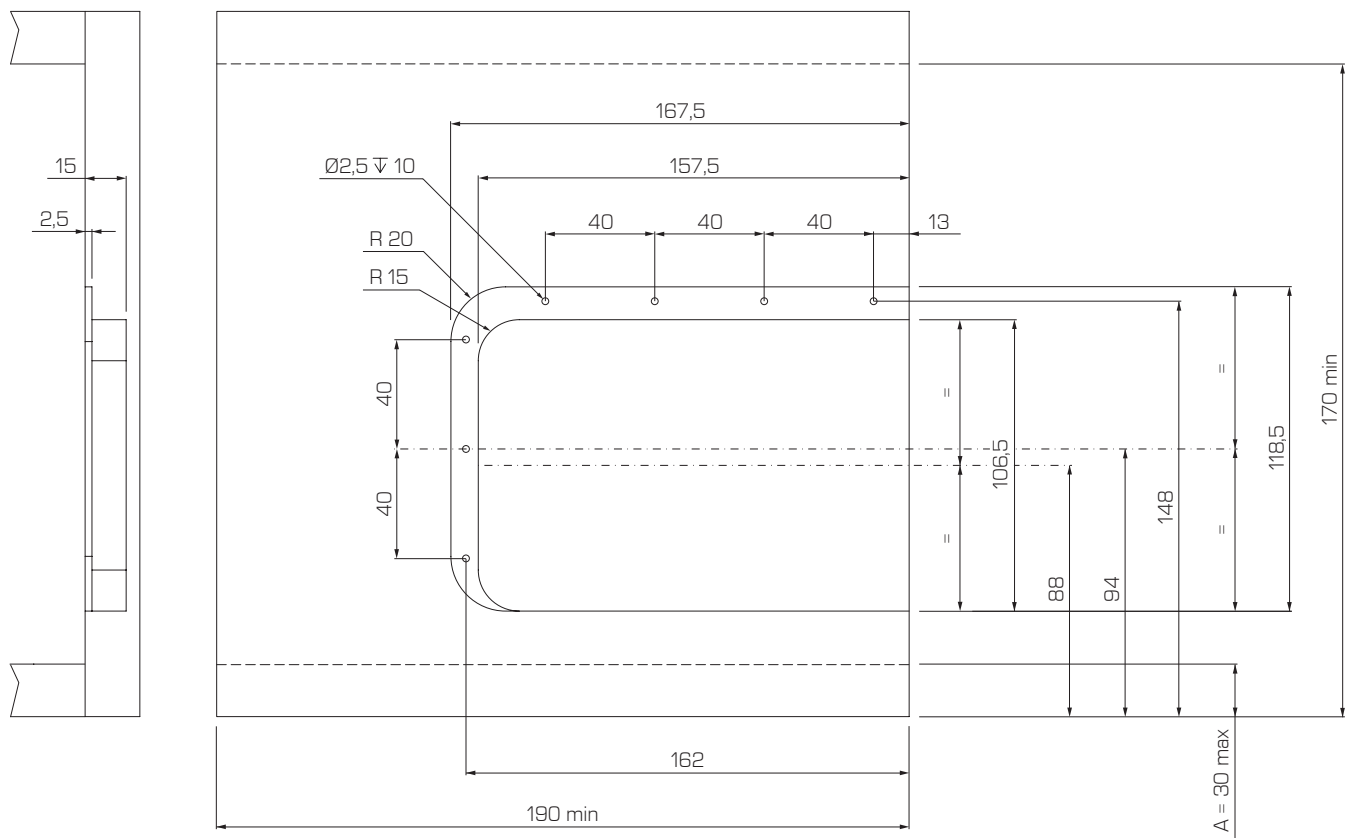
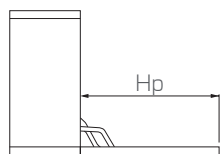

Montaggio esterno con cover
External mounting with cover



Montaggio incassato in contropalla
Recessed mounting in cover side panel



Montaggio esterno con cover a filo
External mounting with flush cover

1 SET di meccanismi (dx+sx)
1 SET of mechanisms (left+right)

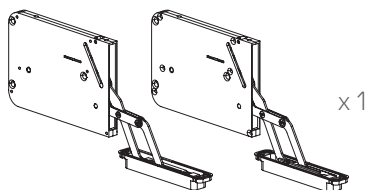

10 SET di cover
(per meccanismi e attacchi anta)
10 SET of covers
(for mechanisms and door connections)

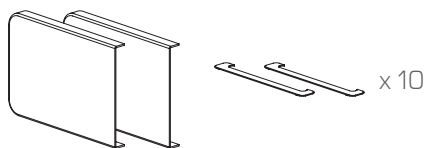

1 SET di meccanismi (dx+sx)
1 SET of mechanisms (left+right)

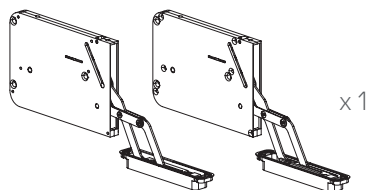

20 cover (per attacchi anta)
20 covers (for door connections)



1 SET di meccanismi (dx+sx)
1 SET of mechanisms (left+right)

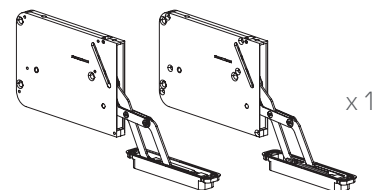

10 SET di piastre (dx+sx)
10 SET of plates (left+right)

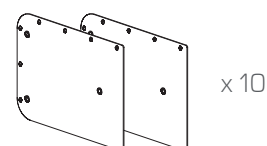

10 SET di cover
(per meccanismi e attacchi anta)
10 SET of covers
(for mechanisms and door connections)

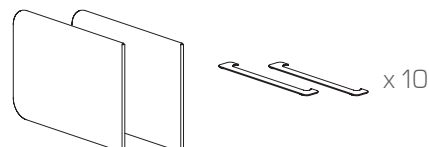

Incluso nel catalogo Effegibrevetti:

Cerniere per:

- Ante a battente
- Ante a ribalta

Fissaggi:

- Orizzontali
- Verticali
- A scatto
- Livellatori
- Reggipiani

Meccanismi per:

- Ante a ribalta
- Ante a pantografo
- Ante a pacchetto
- Ante scorrevoli
- Apertura obliqua
- Apertura verticale

Effegibrevetti ha la facoltà di apportare ai prodotti tutte le modifiche e migliorie tecniche.

Included in Effegibrevetti's catalogue:

Hinges for:

- Swing doors
- Flap doors

Fittings:

- Horizontal
- Vertical
- Snap
- Levellers
- Shelf supports

Mechanisms for:

- Flap doors
- Pantograph doors
- Folding doors
- Sliding doors
- Oblique opening
- Vertical opening

Effegibrevetti reserve the right to make changes and technical improvements to the products.

EFFEGIBREVETTI

Effegibrevetti S.r.l.

Via Cava Trombetta 17/25
20054 Segrate Milano Italy

Tel +39 02 26921838
Fax +39 02 26921737
info@effegibrevetti.com

www.effegibrevetti.com



COMPANY WITH
QUALITY SYSTEM
CERTIFIED BY DNV
ISO 9001