

Shelf support • Supports tablettes

MATERIALE - MATERIAL - MATIÈRE



Ferro (Steel) (Acier)

FINITURA - FINISH - FINITION

FZ - FZT - FNL - FBR - FZN - FO

Mensolina in ferro.

Steel shelf support.
Taquet acier.

Art.	Ø	L	L1	L2	L3		
ME10	5	8	2,9	9,5	7,3	5.000	11,8
ME11	4	8	2	8,5	6,5	10.000	14
ME12	3	8	1,7	12	4,3	20.000	14,4

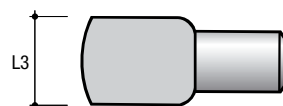
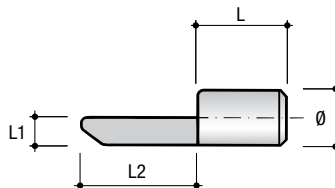
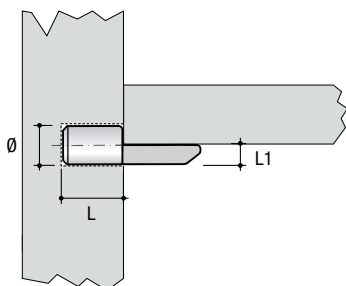

MATERIALE - MATERIAL - MATIÈRE



Ferro (Steel) (Acier)

FINITURA - FINISH - FINITION

FZ - FNL - FZN

Mensolina c/anello.

Shelf support duplo.
Taquet rond avec collerette.

Art.	Ø	= L =		
ME08	5	16	5.000	12

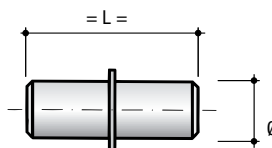
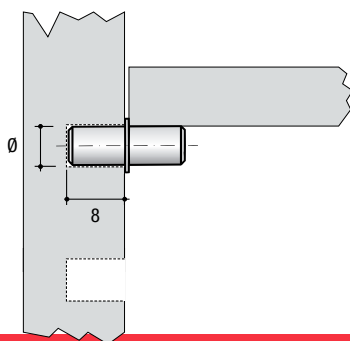

Bloccaripiani



Shelfstopper • Bloc tablettes

MATERIALE - MATERIAL - MATIÈRE

Plastica (Plastic) (Plastique)

FINITURA - FINISH - FINITION

PN

Art.	Ø	H	L	i		
BR01	5	19,5	23,5	16	10.000	6,9
BR02	5	48	25	44	5.000	8,6

