

**CAIMEXPORT**

**ACCESSORI PER MOBILI - FURNITURES HARDWARE**

# **Pocket**

*Sliding System*

Catalogue - 2018

# Pocket

## ANTA ESTERNA / EXTERNAL DOOR 50KG

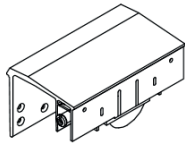
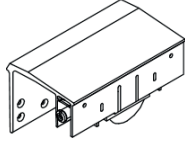
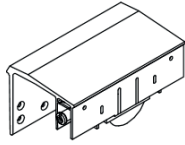
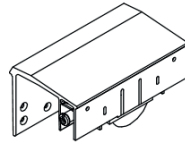
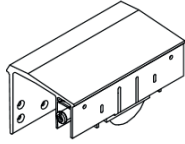
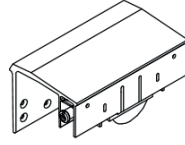
ANTA ESTERNA / EXTERNAL DOOR		COD.	PRICE LIST
<b>EXTRA MINI</b> Spessore anta fino a Door thickness till	<b>18mm</b> <b>18mm</b>	 <b>PK18</b>	
<b>MINI</b> Spessore anta fino a Door thickness till	<b>23mm</b> <b>23mm</b>	 <b>PK23</b>	
<b>EXTRA MIDI</b> Spessore anta fino a Door thickness till	<b>26mm</b> <b>26mm</b>	 <b>PK26</b>	
<b>MIDI</b> Spessore anta fino a Door thickness till	<b>30mm</b> <b>30mm</b>	 <b>PK30</b>	
<b>MAXI</b> Spessore anta fino a Door thickness till	<b>35mm</b> <b>35mm</b>	 <b>PK35</b>	
<b>EXTRA</b> Spessore anta fino a Door thickness till	<b>50mm</b> <b>50mm</b>	 <b>PK50</b>	

# Pocket

## ANTA ESTERNA / EXTERNAL DOOR 70KG

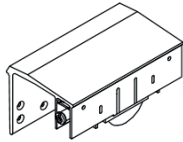
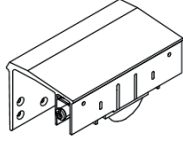
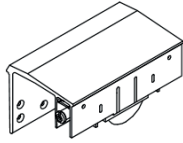
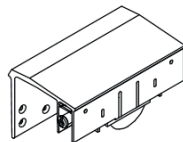
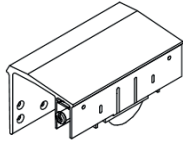
ANTA ESTERNA / EXTERNAL DOOR		COD.	PRICE LIST
<b>MINI STRONG</b> Spessore anta fino a Door thickness till	<b>23mm 23mm</b> 	<b>PK123</b>	
<b>MIDI STRONG</b> Spessore anta fino a Door thickness till	<b>30mm 30mm</b> 	<b>PK130</b>	
<b>MAXI STRONG</b> Spessore anta fino a Door thickness till	<b>35mm 35mm</b> 	<b>PK135</b>	
<b>SUPER MAXI STRONG</b> Spessore anta fino a Door thickness till	<b>40mm 40mm</b> 	<b>PK140</b>	
<b>EXTRA STRONG</b> Spessore anta fino a Door thickness till	<b>50mm 50mm</b> 	<b>PK150</b>	

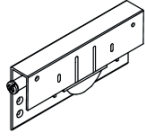

# Pocket

## ANTA INTERNA / INTERNAL DOOR 70KG

ANTA INTERNA / INTERNAL DOOR		COD.	PRICE LIST
<b>UNIVERSAL TRUCK</b>		<b>PK141</b>	
Spessore anta fino a <b>50mm</b> Door thickness till <b>50mm</b>			



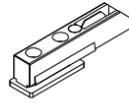



# Pocket

## STOPPER / DAMPER

STOPPER / DAMPER		COD.	PRICE LIST
<b>PUK92</b>		<b>PUK92</b>	
Fermo superiore ammortizzato Soft upper damper			
<b>PK92</b>		<b>PK92</b>	
Fermo superiore in battuta Upper stopper without soft			
<b>ML93</b>		<b>ML93</b>	
Fermo inferiore in battuta Lower stopper without soft			

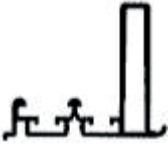



# Pocket

## BINARI CON QUICK / RAILS QUICK SYSTEM

BINARI / RAILS		COD.	PRICE LIST	
			ROW	ANODIZED
<b>MQ10</b> Binario superiore Upper rail		<b>MQ10</b>		
<b>MQ13</b> Binario superiore aletta Upper rail with fin		<b>MQ13</b>		
<b>MQ16</b> Binario superiore Upper rail reinforced		<b>MQ16</b>		
<b>MQ20</b> Binario inferiore Lower rail		<b>MQ20</b>		
<b>MQ910</b> Blocco superiore Upper rail hook clip		<b>MQ910</b>		
<b>MQ911</b> Aggancio superiore Upper rail clip		<b>MQ911</b>		
<b>MQ920</b> Aggancio inferiore Lower rail clip		<b>MQ920</b>		

# Pocket

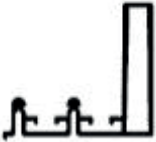
## BINARI CON FISSAGGIO A VITI / RAILS SCREW

BINARI / RAILS		COD.	PRICE LIST	
			ROW	ANODIZED
<b>ML10</b> Binario superiore Upper rail		<b>ML10</b>		
<b>ML13</b> Binario superiore aletta Upper rail with fin		<b>ML13</b>		
<b>ML16</b> Binario superiore Upper rail reinforced		<b>ML16</b>		
<b>ML20</b> Binario inferiore Lower rail		<b>ML20</b>		

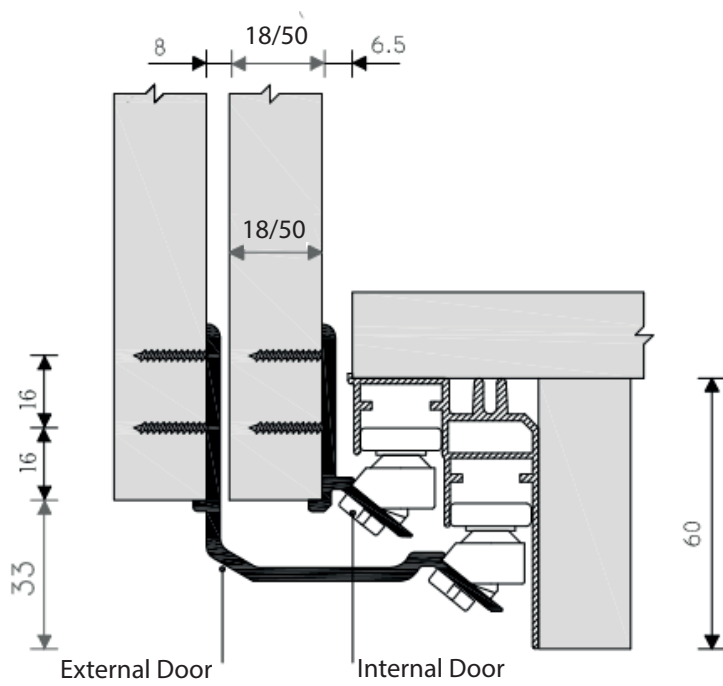
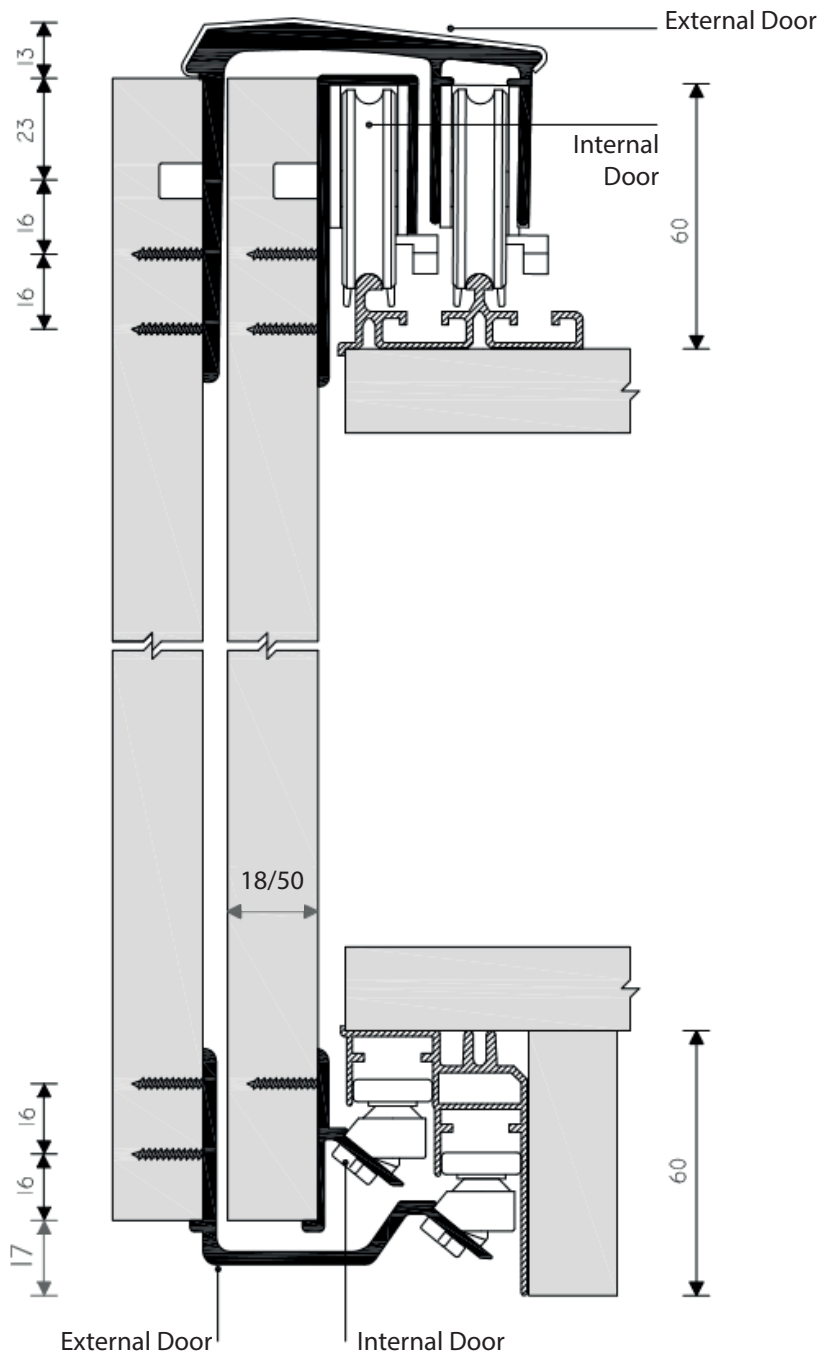

ANTA INTERNA - INTERNAL DOOR

ANTA ESTERNA - EXTERNAL DOOR

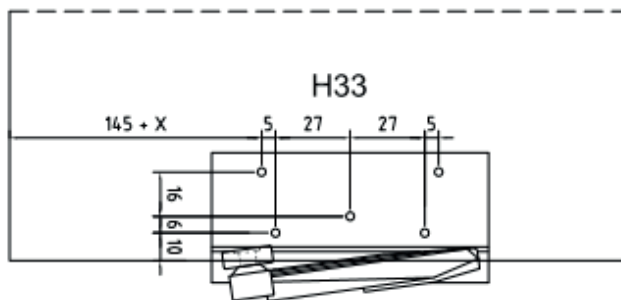
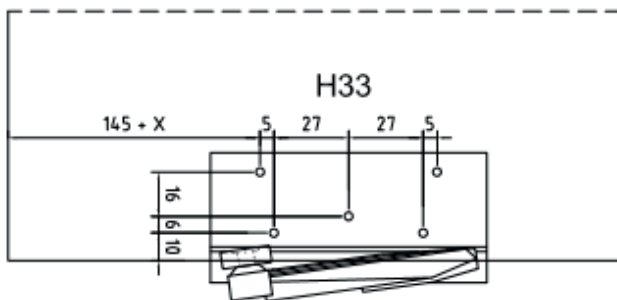
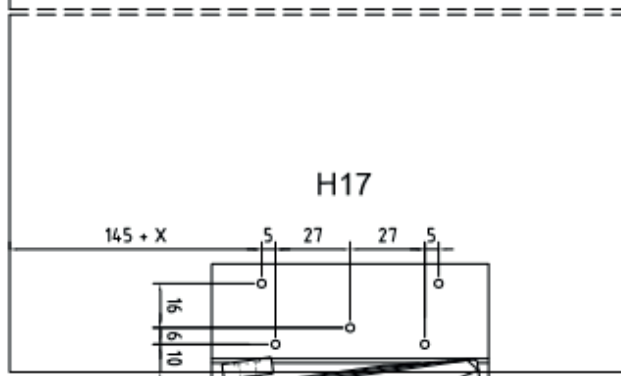
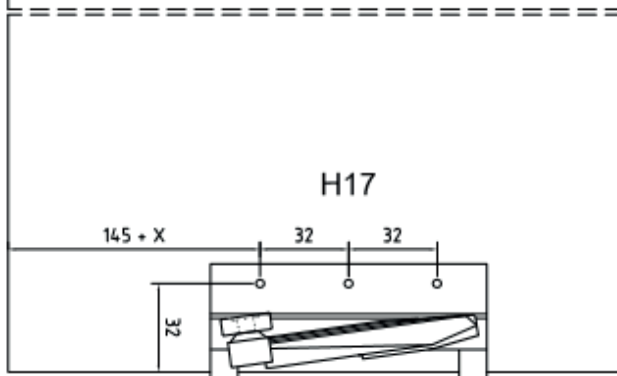
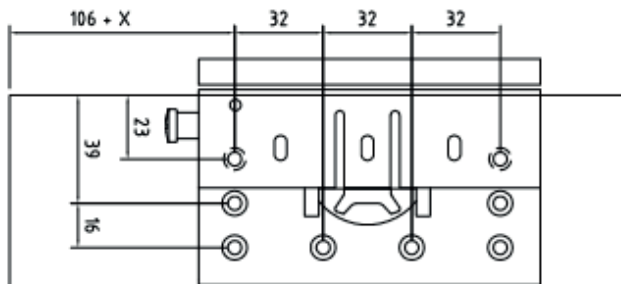
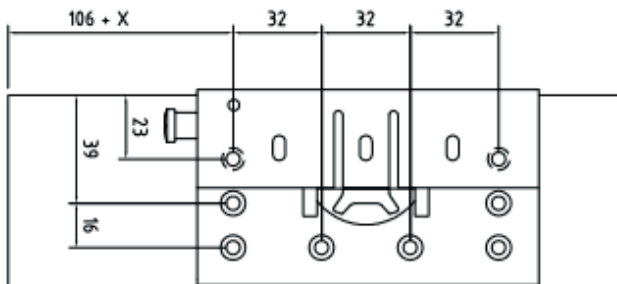

X = SORMONTO ANTA / DOOR OVERLAY



# CAIMIEXPORT

**Caimi srl**

Via Provinciale,31  
22060 Novedrate - CO - Italy  
P.Iva 08485910965  
Tel. +39 031 3510111  
Fax. +39 031 3510405  
[www.caimiexport.it](http://www.caimiexport.it)