

**Sistemi di scorrimento  
per ante a libro singole  
o multiple libere**

Sliding system for folding single or multiple free doors  
Systèmes de coulissement pour portes pliantes simples ou multiples libres  
System für Einzel-Faltdüren oder für mehrfache, freilaufende Türen  
Sistemas de deslizamiento para puertas de librillo individuales o múltiples libres



Sistemi di scorrimento per ante a libro singole o multiple incernierate

Sliding system for folding single or multiple hinged doors

Systèmes de coulissement pour portes pliantes simples ou multiples articulées

System für Einzel-Faltdüren oder für mehrfache Türen mit Scharnieren

Sistemas de deslizamiento para puertas de librillo individuales o múltiples con bisagra

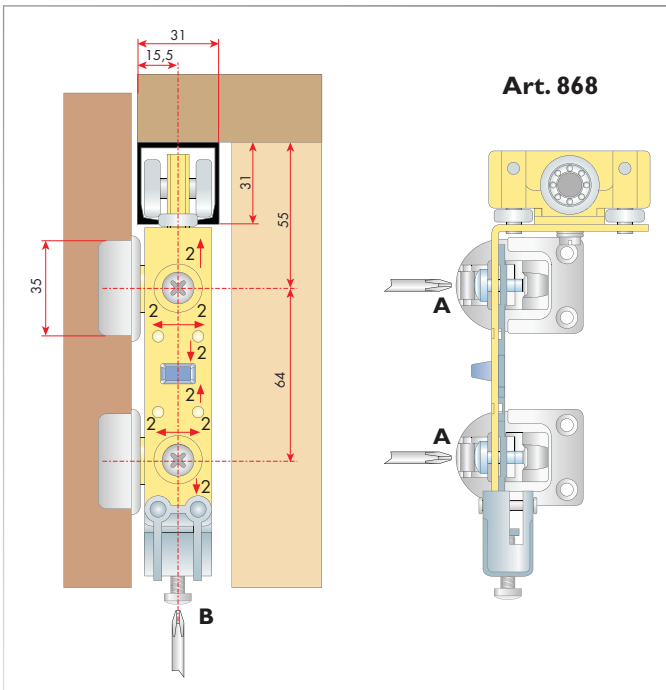

**Art. 868**

Scorrevole a due cuscinetti con regolazione orizzontale e verticale.  
Slide with two bearings with horizontal and vertical adjustment.  
Coulisse à deux coussinets avec réglage horizontal et vertical.  
Schlitten mit zwei Lagern, horizontale und vertikale Regulierung.  
Elemento de deslizamiento con dos cojinetes y ajuste horizontal y vertical.

Per la regolazione orizzontale: agire sulle viti A, regolare e bloccare.  
Per la regolazione verticale: Allentare le viti A, agire con la vite B, infine bloccare le viti A.  
Use screws A for horizontal adjustment, lock them when finished.  
For vertical adjustment: Loosen screws A, adjust screw B, lock screws A.  
Pour le réglage horizontal, agir sur les vis A, régler et serrer.  
Pour le réglage vertical: Desserrer les vis A, agir sur la vis B, enfin serrer les vis A.

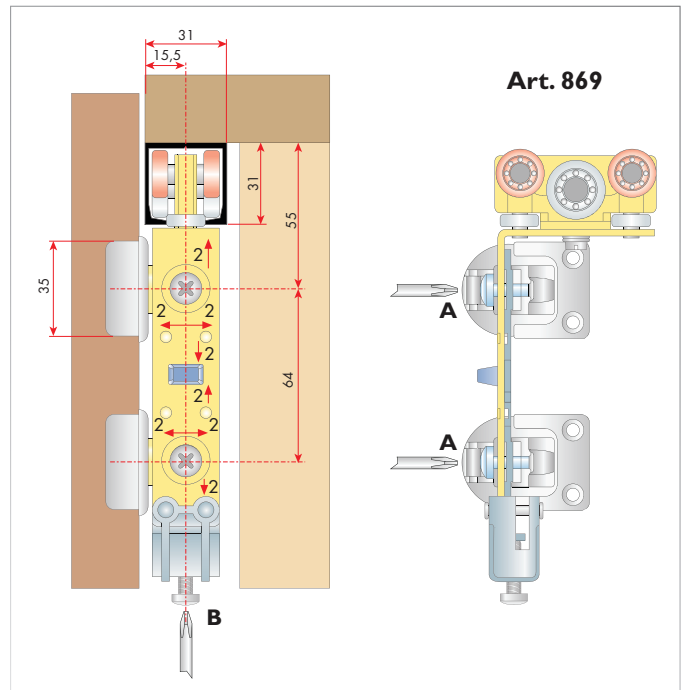

**Art. 869**

Die horizontale Regulierung erfolgt mittels der Schrauben A, einstellen und festschrauben.

Für die vertikale Regulierung: Die Schrauben A lockern, Schraube B verstellen und Schrauben A festschrauben.  
Para ajustar horizontalmente el elemento, actuar sobre los tornillos A. Regular la posición y, luego, bloquear los tornillos.  
Para ajustar verticalmente el elemento, efectuar las siguientes operaciones: Aflojar los tornillos A, actuar con el tornillo B y, luego, bloquear los tornillos A.

Scorrevole a sei cuscinetti con regolazione orizzontale e verticale.  
Slide with six bearings with horizontal and vertical adjustment.  
Coulisse à six coussinets avec réglage horizontal et vertical.  
Schlitten mit sechs Lagern, horizontale und vertikale Regulierung.  
Elemento de deslizamiento con seis cojinetes y ajuste horizontal y vertical.

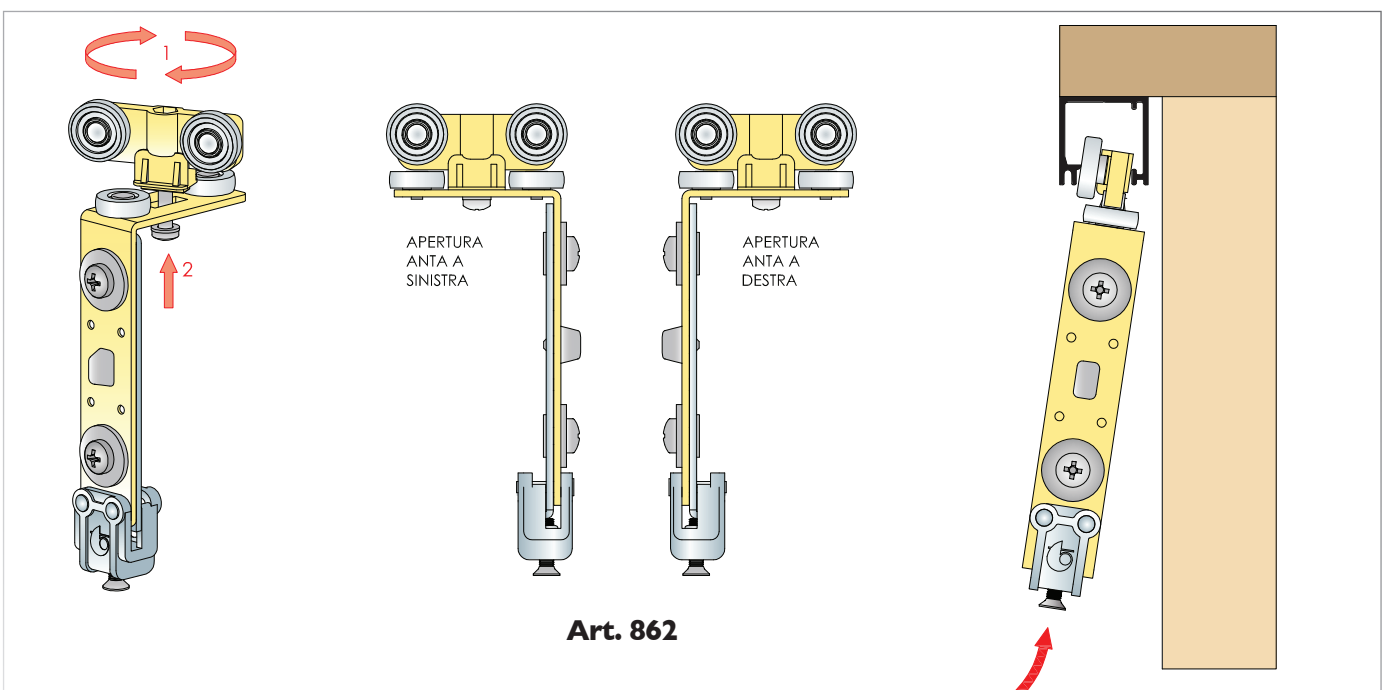

**Art. 862**

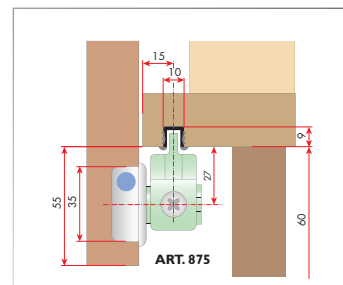
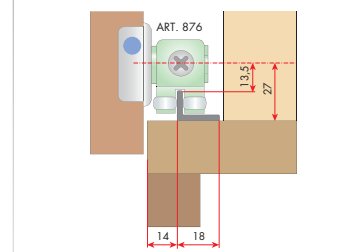
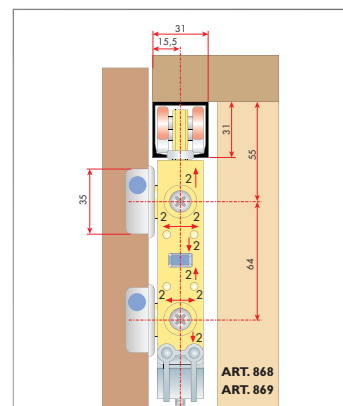
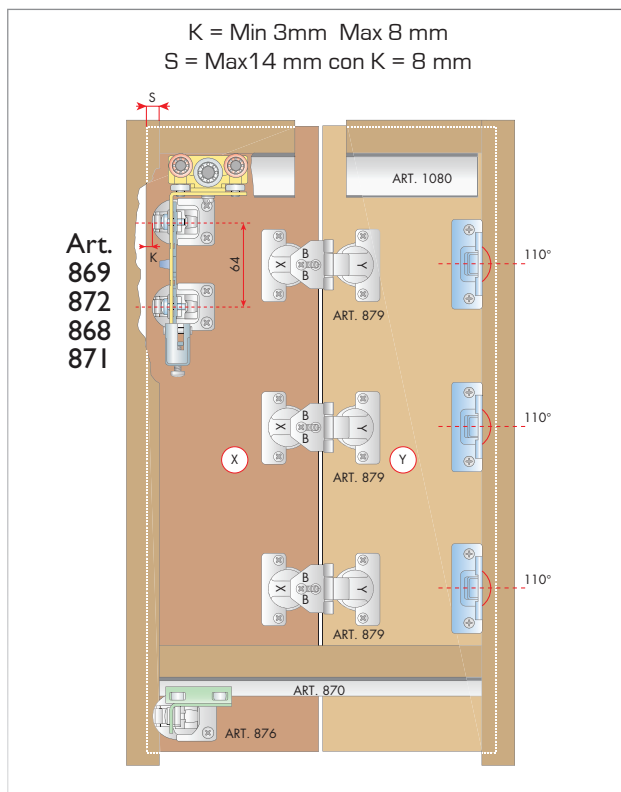
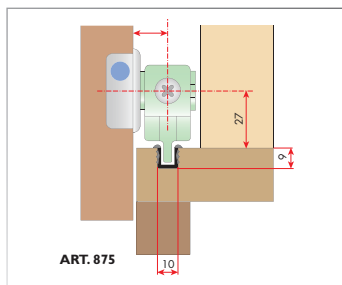
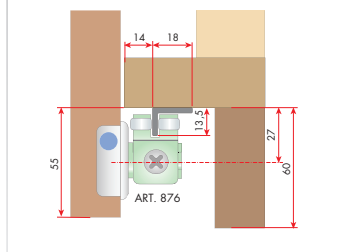
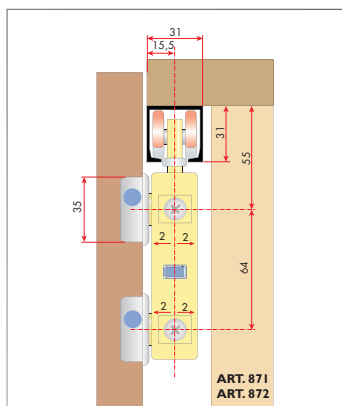



**ART. 892**  
 Profilo biestruato parapolvere  
 Biextended anti-dust profile  
 Profilé bi-extrudé pare-poussière  
 Doppelgepreßtes staubabweisendes Profil  
 Perfil biextruido salvapolvere



**ART. 1080**  
 Binario in alluminio  
 Aluminium track  
 Profilé en aluminium  
 Aluminiumschiene  
 Guia de aluminio

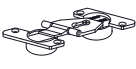

**ART. 870**  
 Binario in alluminio  
 Aluminium track  
 Profilé en aluminium  
 Aluminiumschiene  
 Guia de aluminio



**ART. 879**  
 Cerniera  
 Hinge  
 Charnière  
 Scharnier  
 Bisagra



**ART. 876**  
 Scorrevole con una cerniera  
 One-hinge slider  
 Coulissant à une charnière  
 Schieber mit eine Scharnier  
 Elem. de deslizamiento con una bisagra

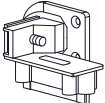

**ART. 875**  
 Scorrevole con una cerniera  
 One-hinge slider  
 Coulissant à une charnière  
 Schieber mit eine Scharnier  
 Elem. de deslizamiento con una bisagra

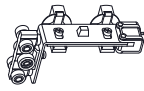

**ART. 869**  
 Scorrevole regolabile con 6 cuscinetti  
 Adjustable slide with 6 bearings  
 Coulisse réglable avec 6 coussinets.  
 Regulierbarer Schlitten mit 6 Lagern  
 Elem. de deslizam. ajustable con 6 cojinetes



**ART. 868/CS**  
 Scorrevole regolabile con 2 cuscinetti  
 Adjustable slide with 2 bearings  
 Coulisse réglable avec 2 coussinets.  
 Regulierbarer Schlitten mit 2 Lagern  
 Elem. de deslizam. ajustable con 2 cojinetes

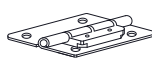

**ART. 888**  
 Cerniera  
 Hinge  
 Charnière  
 Scharnier  
 Bisagra



**ART. 868/RD**  
 Scorrevole con 2 ruote delrin  
 Slide with 2 delrin wheels  
 Coulisse avec 2 roues en delrin.  
 Schlitten mit 2 Delrin Rollen  
 Elem. de deslizam. con 2 ruedas delrin



**ART. 872**  
 Scorrevole con 6 cuscinetti  
 Slide with 6 bearings  
 Coulisse avec 6 coussinets.  
 Schlitten mit 6 Lagern  
 Elem. de deslizam. con 6 cojinetes



**ART. 871/CS**  
 Scorrevole con 2 cuscinetti  
 Slide with 2 bearings  
 Coulisse avec 2 coussinets.  
 Schlitten mit 2 Lagern  
 Elem. de deslizam. con 2 cojinetes

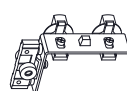

**ART. 871/RD**  
 Scorrevole con 2 ruote delrin  
 Slide with 2 delrin wheels  
 Coulisse avec 2 roues en delrin.  
 Schlitten mit 2 Delrin Rollen  
 Elem. de deslizam. con 2 ruedas delrin

# Sistema per anta a libro incernierata

System for hinged folding doors  
 Systeme pour porte pliante articulée  
 System für falttür mit scharnier  
 Sistema para puerta de librillo con bisagra

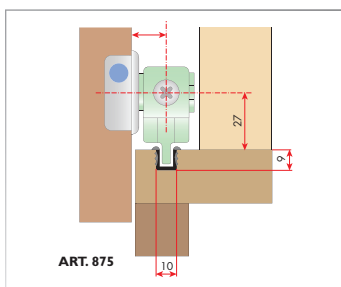
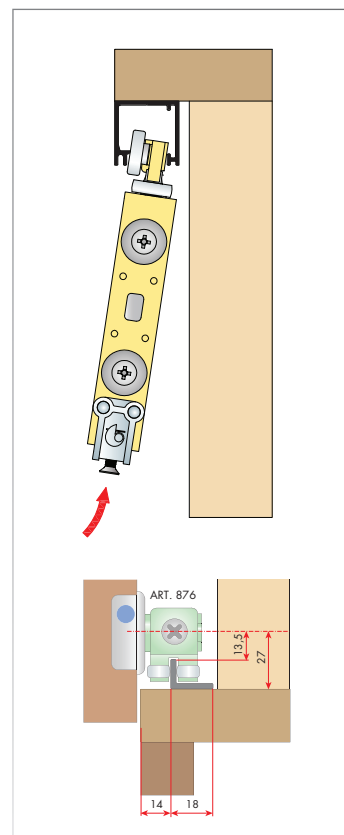
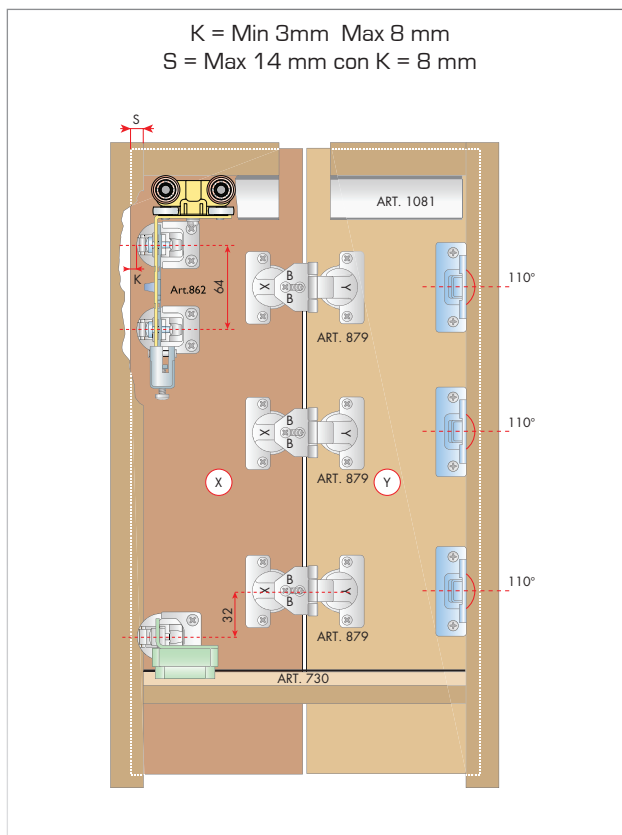
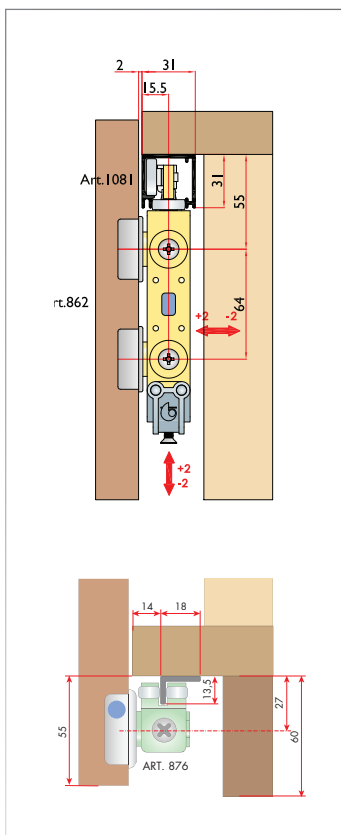

Il peso delle ante "X" e "Y" deve essere sostenuto maggiormente dalle cerniere 110°  
 The weight of the "X" and "Y" doors must be supported mostly by the 110° hinges  
 Le poids des portes "X" et "Y" doit être soutenu en grande partie par les charnières 110°  
 Das Gewicht der Türen "X" und "Y" lastet zum Großteil auf den Scharnieren 110°  
 La mayor parte del peso de las puertas "X" e "Y" tiene que ser sostenido por las bisagras 110°

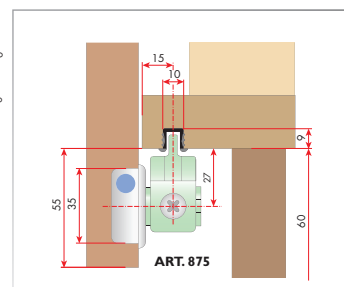

ANTE A LIBRO PER ARMADI

**ART. 1081**  
 Binario in alluminio  
 Aluminium track  
 Profilé en aluminium  
 Aluminiumschiene  
 Guia de aluminio

**ART. 870**  
 Binario in alluminio  
 Aluminium track  
 Profilé en aluminium  
 Aluminiumschiene  
 Guia de aluminio

**ART. 879**  
 Cerniera  
 Hinge  
 Charnière  
 Scharnier  
 Bisagra

**ART. 875**  
 Scorrevole con una cerniera  
 One-hinge slider  
 Coulissant à une charnière  
 Schieber mit eine Scharnier  
 Elem. de deslizamiento con una bisagra

**ART. 892**  
 Profilo biestruso parapolvere  
 Biextended anti-dust profile  
 Profilé bi-extrudé pare-poussière  
 Doppelgepreßtes staubabweisendes Profil  
 Perfil biextruido salvapolvo

**ART. 888**  
 Cerniera  
 Hinge  
 Charnière  
 Scharnier  
 Bisagra

**ART. 862**  
 Scorrevole regolabile con 6 cuscinetti  
 Adjustable slide with 6 bearings  
 Coulisse réglable avec 6 coussinets  
 Regulierbarer Schlitzen mit 6 Lagern  
 Elem. de deslizam. ajustable con 6 cojinetes

**ART. 876**  
 Scorrevole con una cerniera  
 One-hinge slider  
 Coulissant à une charnière  
 Schieber mit eine Scharnier  
 Elem. de deslizamiento con una bisagra

K = Min 3mm Max 8 mm  
S = Max 14 mm con K = 8 mm

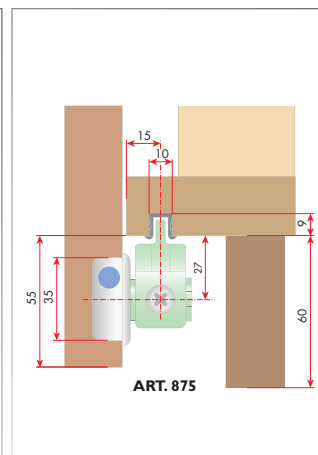
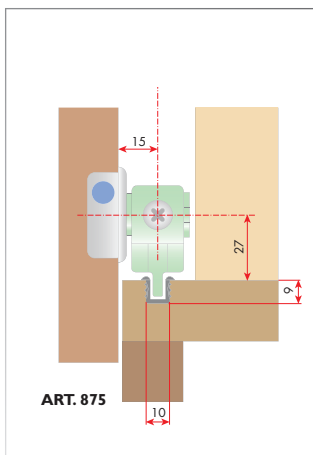
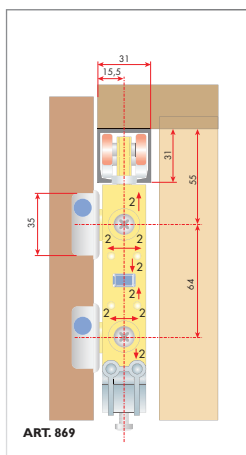
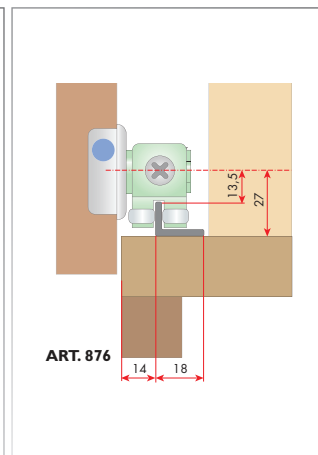
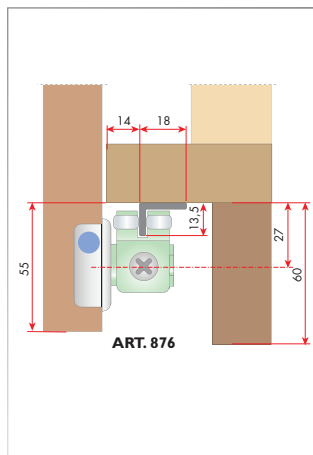
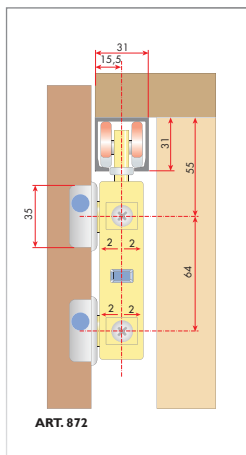
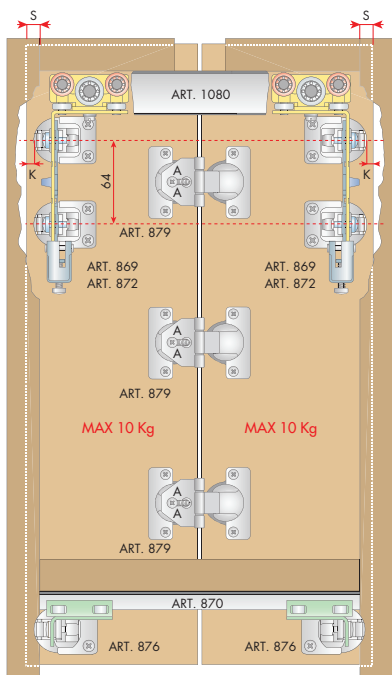

ANTE A LIBRO PER ARMADI

Gli articoli 883 si possono usare in alternativa agli articoli 879.  
Articles 883 can be used instead of article 879.  
Les articles 883 peuvent être utilisés à la place des articles 879.  
Die Artikel 883 sind als Alternative zu den Artikeln 879 verwendbar.  
Los artículos 883 se pueden usar como alternativa de los artículos 879.

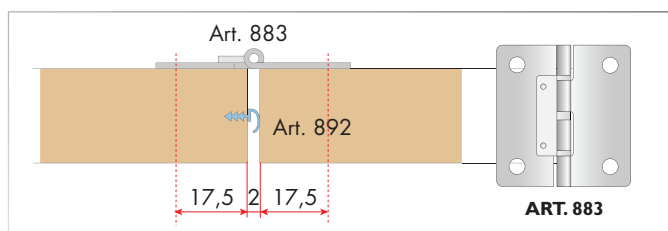

**ART. 875**  
Scivolante con una cerniera  
One-hinge slider  
Coulissant à une charnière  
Schieber mit eine Scharnier  
Elem. de deslizamiento con una bisagra



**ART. 1080**  
Binario in alluminio  
Aluminium track  
Profilé en aluminium  
Aluminiumschiene  
Guia de aluminio



**ART. 870**  
Binario in alluminio  
Aluminium track  
Profilé en aluminium  
Aluminiumschiene  
Guia de aluminio



**ART. 879**  
Cerniera  
Hinge  
Charnière  
Scharnier  
Bisagra

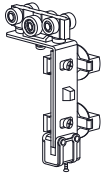

**ART. 869**  
Scorrevole regolabile con 6 cuscinetti  
Adjustable slide with 6 bearings  
Coulisse réglable avec 6 coussinets.  
Regulierbarer Schlitten mit 6 Lagern  
Elem. de deslizam. ajustable con 6 cojinetes

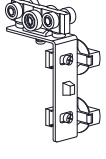

**ART. 872**  
Scorrevole con 6 cuscinetti  
Slide with 6 bearings  
Coulisse avec 6 coussinets.  
Schlitten mit 6 Lagern  
Elem. de deslizam. con 6 cojinetes



**ART. 892**  
Profilo biesteso parapolvere  
Biextended anti-dust profile  
Profilé biextrudé pare-poussière  
Doppelgepreßtes staubabweisendes Profil  
Perfil biextruido salvapovo

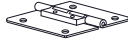

**ART. 883**  
Cerniera  
Hinge  
Charnière  
Scharnier  
Bisagra



**ART. 876**  
Scorrevole con una cerniera  
One-hinge slider  
Coulissant à une charnière  
Schieber mit eine Scharnier  
Elem. de deslizamiento con una bisagra

# Sistema per anta a libro singola libera

System for single free folding doors  
 Systeme pour une seule porte pliante libre  
 System für eintürige falttür ohne scharnier  
 Sistema para puerta de librillo individual libre

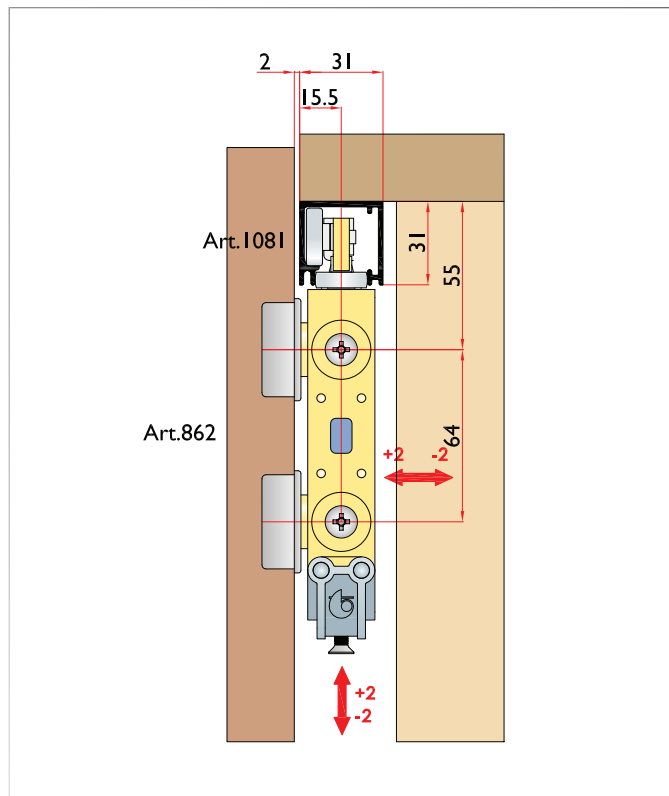
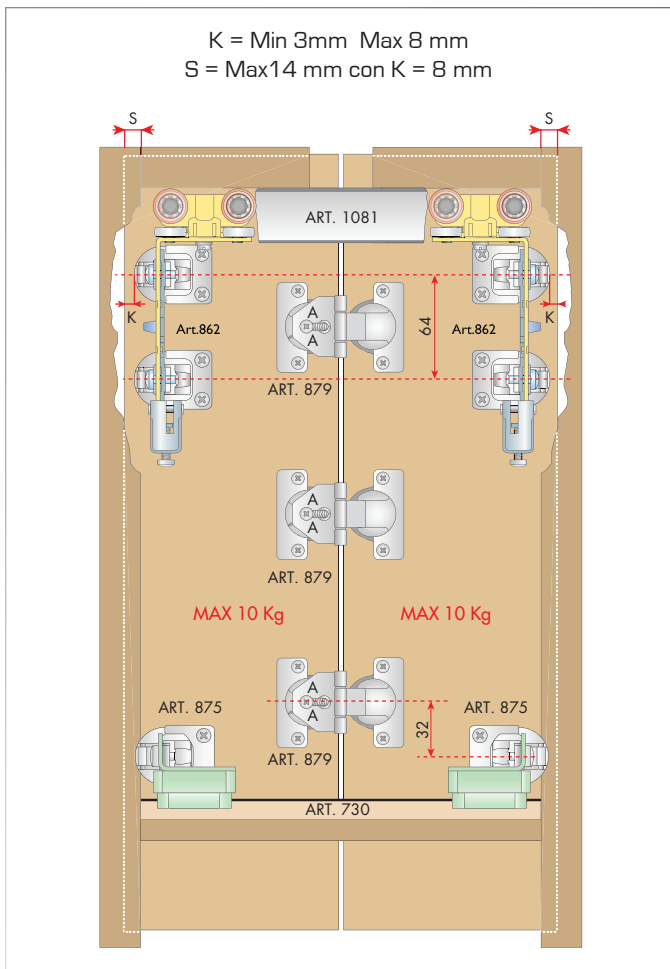

Gli articoli 883 si possono usare in alternativa agli articoli 879.  
 Articles 883 can be used instead of article 879.  
 Les articles 883 peuvent être utilisés à la place des articles 879.  
 Die Artikel 883 sind als Alternative zu den Artikeln 879 verwendbar.  
 Los artículos 883 se pueden usar como alternativa de los artículos 879.

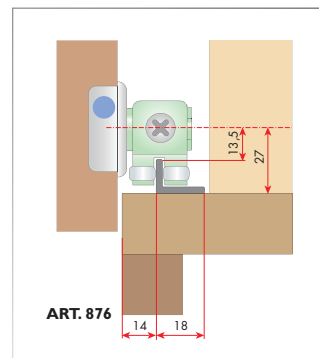
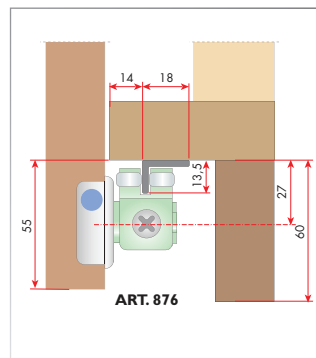
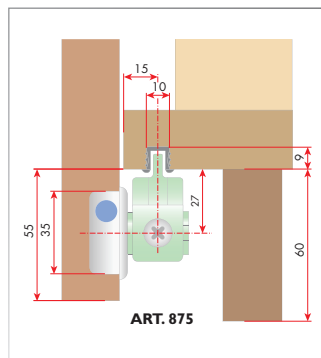
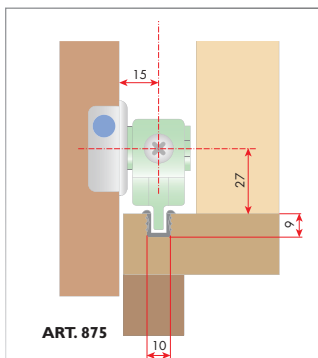

**ART. 1081**  
 Binario in alluminio  
 Aluminium track  
 Profilé en aluminium  
 Aluminiumschiene  
 Guia de aluminio

**ART. 730**  
 Binario in plastica  
 Plastic track  
 Rail en plastique  
 Plastikprofil  
 Carril de plastico

**ART. 879**  
 Cerniera  
 Hinge  
 Charnière  
 Scharnier  
 Bisagra

**ART. 862**  
 Scorrevole regolabile con 6 cuscinetti  
 Adjustable slide with 6 bearings  
 Coulisse réglable avec 6 coussinets.  
 Regulierbarer Schlitten mit 6 Lagern  
 Elem. de deslizam. ajustable con 6 cojinetes

**ART. 875**  
 Scivolante con una cerniera  
 One-hinge slider  
 Coulissant à une charnière  
 Schieber mit eine Scharnier  
 Elem. de desliz. con una bisagra

**ART. 892**  
 Profilo biestruato parapolvere  
 Biextruded anti-dust profile  
 Profilé bi-extrudé pare-poussière  
 Doppelgepreßtes staubabweisendes Profil  
 Perfil biextruido salvap polvo

**ART. 883**  
 Cerniera  
 Hinge  
 Charnière  
 Scharnier  
 Bisagra

**ART. 876**  
 Scorrevole con una cerniera  
 One-hinge slider  
 Coulissant à une charnière  
 Schieber mit eine Scharnier  
 Elem. de deslizamiento con una bisagra

ANTE A LIBRO PER ARMADI

# Sistema per ante a libro multiple incernierate

System for multiple hinged folding doors  
 Systeme pour plusieurs portes pliantes articulées  
 System für mehrtürige falttür mit scharnier  
 Sistema para puerta de librillo individual con bisagra



ANTE A LIBRO PER ARMADI

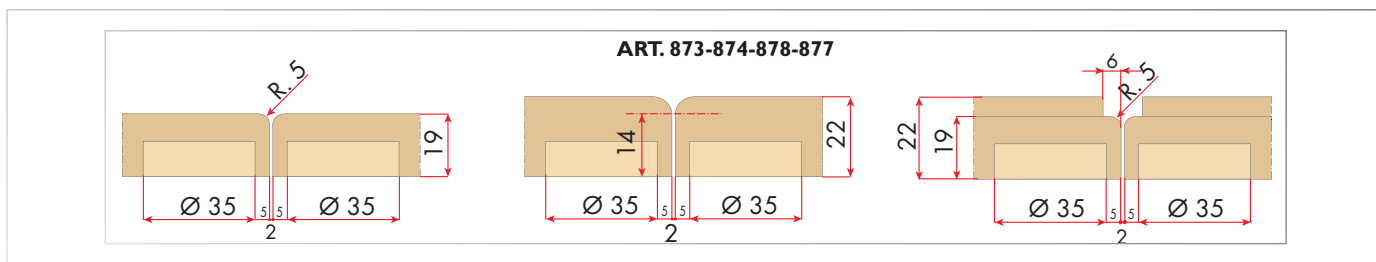
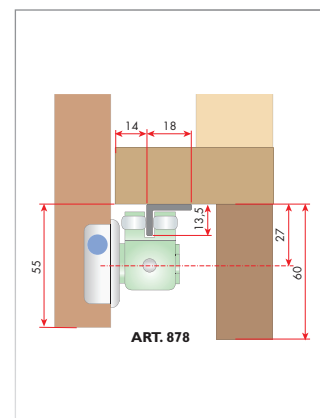
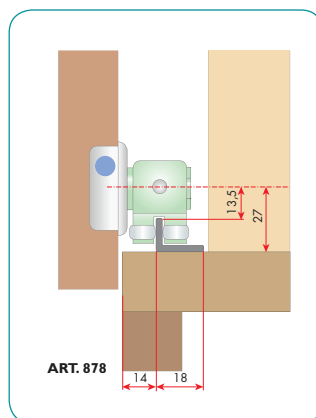
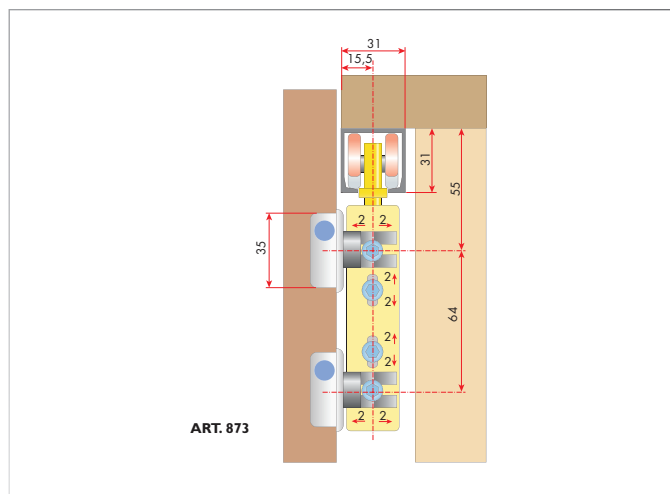
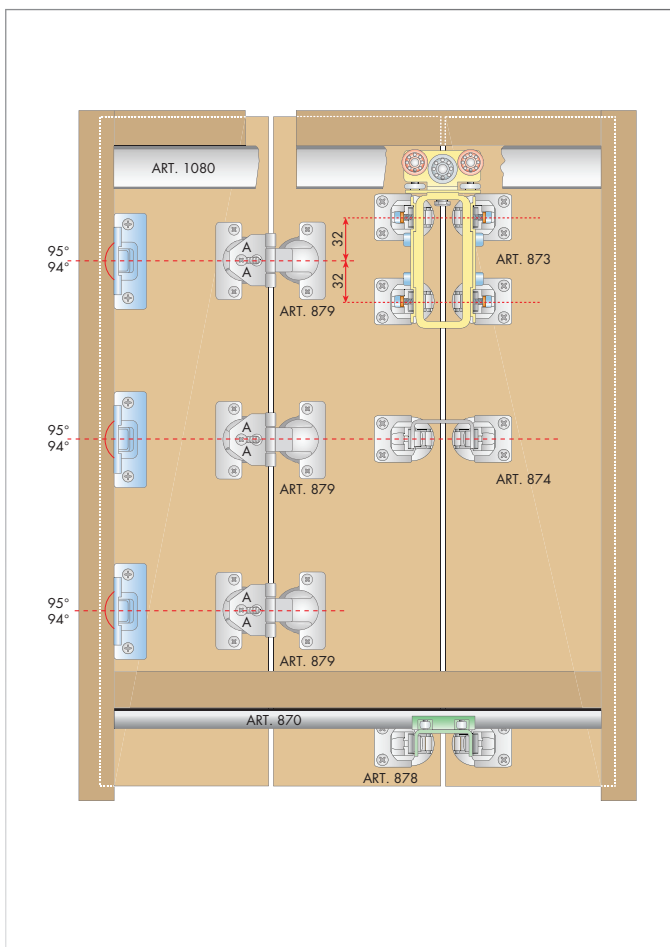

Il peso delle ante deve essere sostenuto maggiormente dalle cerniere 94° - 95°  
 The weight of the doors must be supported mostly by the 94° - 95° hinges  
 Le poids des portes doit être soutenu en grande partie par les charnières 94° - 95°  
 Das Gewicht der Türen lastet zum Großteil auf den Scharnieren 94° - 95°  
 La mayor parte del peso de las puertas tiene que ser sostenido por las bisagras 94° - 95°

**ART. 1080**  
 Binario in alluminio  
 Aluminium track  
 Profilé en aluminium  
 Aluminiumschiene  
 Guía de aluminio

**ART. 894**  
 Profilo biestruo parapolvere  
 Biextruded anti-dust profile  
 Profilé bi-extrudé pare-poussière  
 Doppelgepreßtes staubabweisendes Profil  
 Perfil biextruido salvapolvo

**ART. 870**  
 Binario in alluminio  
 Aluminium track  
 Profilé en aluminium  
 Aluminiumschiene  
 Guía de aluminio

**ART. 873**  
 Scorrevole con quattro cerniere  
 Four-hinge slider  
 Coulissant à quatre charnières  
 Schieber mit vier scharnier  
 Elemento de deslizamiento con cuatro bisagras

**ART. 878**  
 Scorrevole con due cerniere  
 Double-hinge slider  
 Coulissant à double charnière  
 Schieber mit Doppelscharnier  
 Elem. de deslizamiento con una bisagra

**ART. 879**  
 Cerniera  
 Hinge  
 Charnière  
 Scharnier  
 Bisagra

**ART. 874**  
 Giunzione con due cerniere  
 A two-hinged joint  
 Joint (assemblage) avec deux charnières  
 Verbindungsstück mit zwei Scharnieren  
 Junta con dos bisagras

# Sistema per ante a libro multiple incernierate

System for multiple hinged folding doors  
 Systeme pour plusieurs portes pliantes articulées  
 System für mehrtürige falttür mit scharnier  
 Sistema para puerta de librillo individual con bisagra

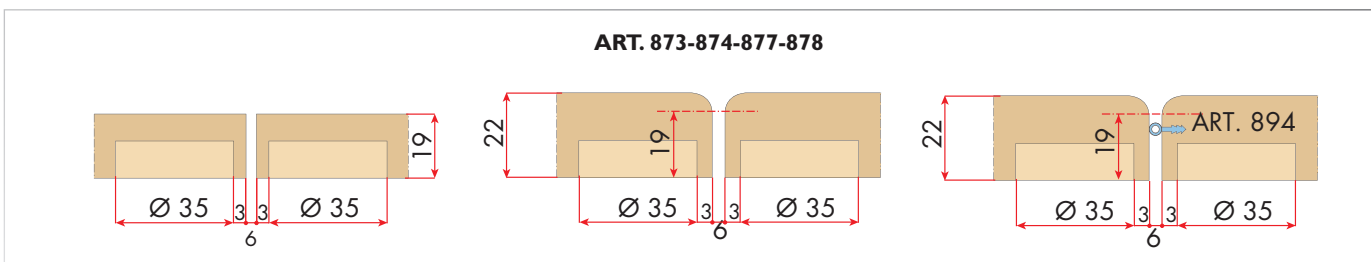
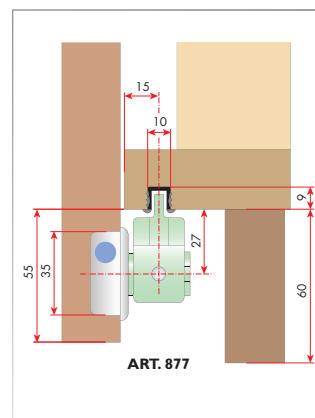
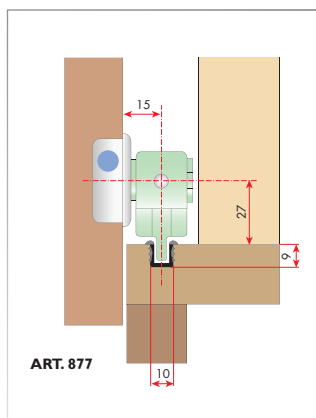
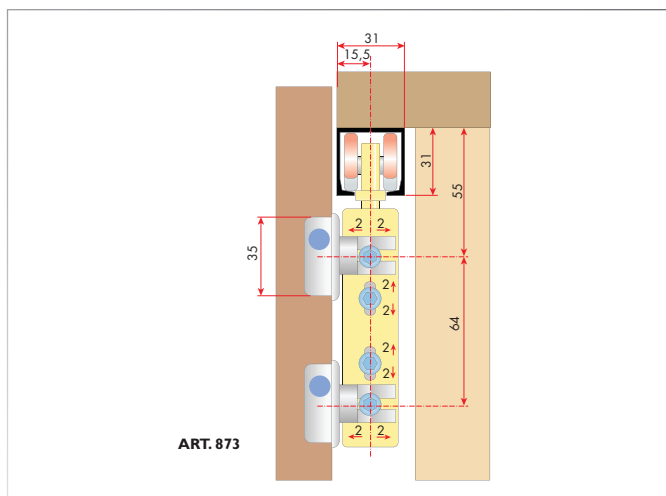
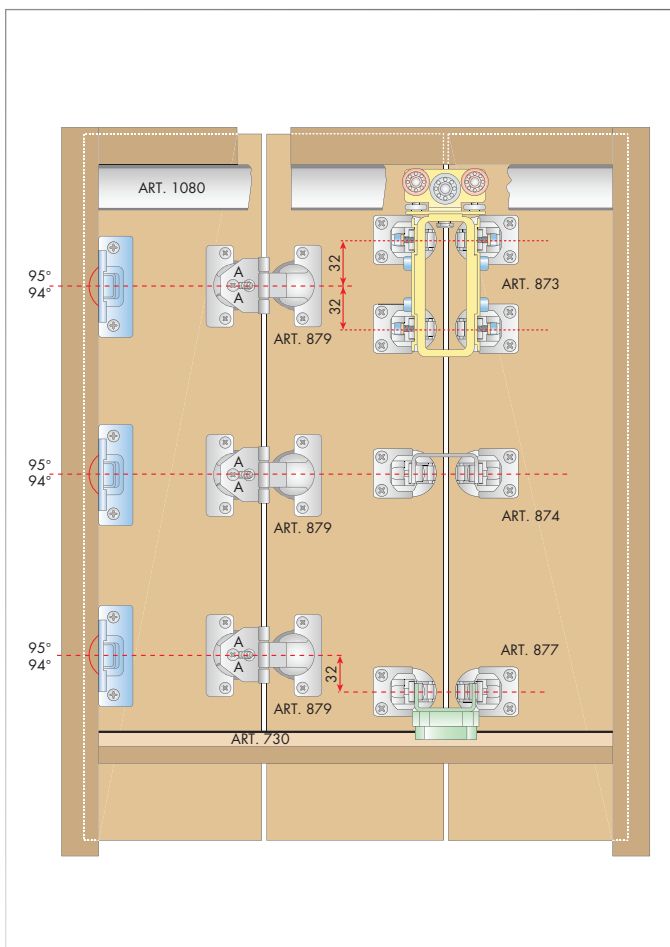

Il peso delle ante deve essere sostenuto maggiormente dalle cerniere 94° - 95°  
 The weight of the doors must be supported mostly by the 94° - 95° hinges  
 Le poids des portes doit être soutenu en grande partie par les charnières 94° - 95°  
 Das Gewicht der Türen lastet zum Großteil auf den Scharnieren 94° - 95°  
 La mayor parte del peso de las puertas tiene que ser sostenido por las bisagras 94° - 95°

**ART. 1080**  
 Binario in alluminio  
 Aluminium track  
 Profilé en aluminium  
 Aluminiumschiene  
 Guía de aluminio

**ART. 894**  
 Profilo biestruo parapolvere  
 Biextended anti-dust profile  
 Profilé biextrudé pare-poussière  
 Doppelgepreßtes staubabweisendes Profil  
 Perfil biextruido salvapvolo

**ART. 730**  
 Binario in plastica  
 Plastic track  
 Rail en plastique  
 Plastikprofil  
 Carril de plastico

**ART. 873**  
 Scorrevole con quattro cerniere  
 Four-hinge slider  
 Couissant à quatre charnières  
 Schieber mit vier scharnier  
 Elemento de deslizamiento con cuatro bisagras

**ART. 877**  
 Scorrevole con due cerniere  
 Double-hinge slider  
 Couissant à double charnière  
 Schieber mit Doppelscharnier  
 Elem. de deslizamiento con una bisagra

**ART. 879**  
 Cerniera  
 Hinge  
 Charnière  
 Scharnier  
 Bisagra

**ART. 874**  
 Giunzione con due cerniere  
 A two-hinged joint  
 Joint (assemblage) avec deux charnières  
 Verbindungsstück mit zwei Scharnieren  
 Junta con dos bisagras

ANTE A LIBRO PER ARMADI



# Sistema per ante a libro multiple incernierate

System for multiple hinged folding doors  
 Systeme pour plusieurs portes pliantes articulées  
 System für mehrtürige falttür mit scharnier  
 Sistema para puerta de librillo individual con bisagra



ANTE A LIBRO PER ARMADI

K = Min 3mm Max 8 mm  
 S = Max14 mm con K = 8 mm

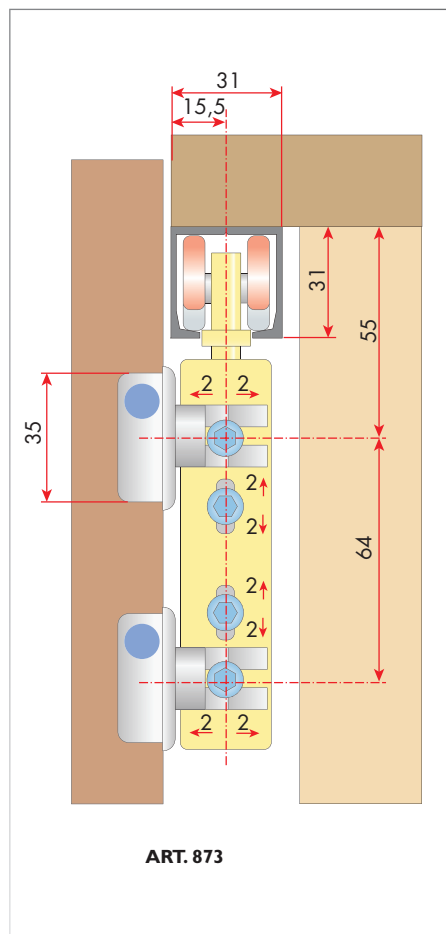
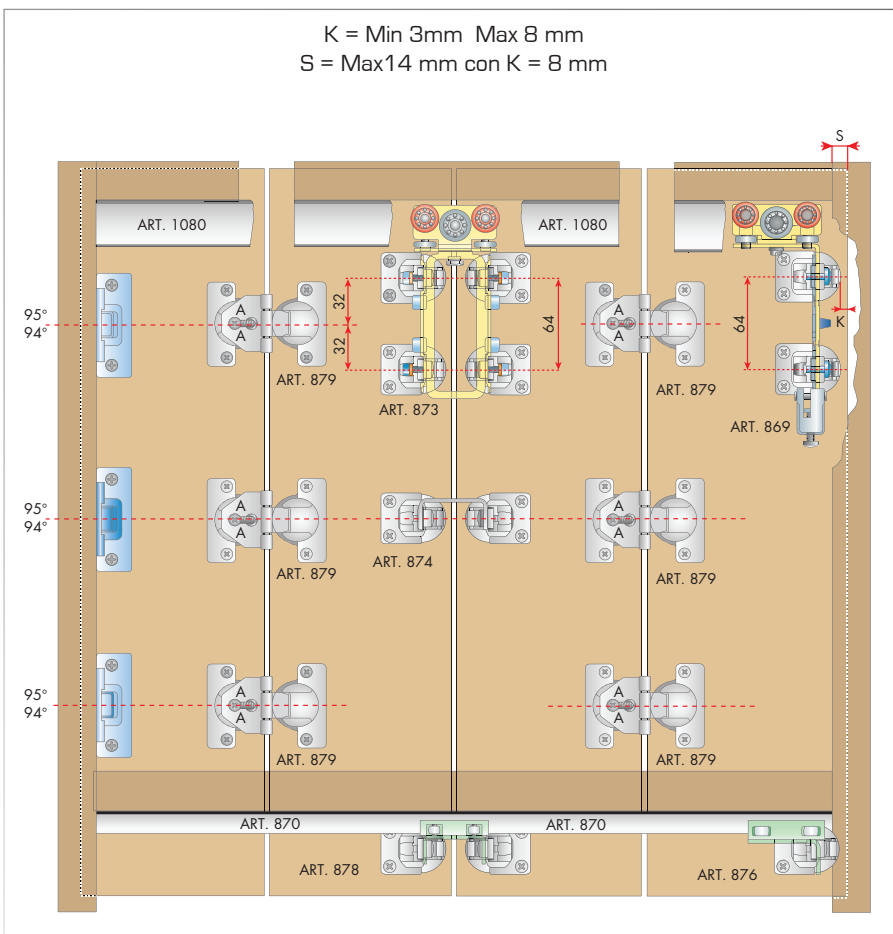

Il peso delle ante deve essere sostenuto maggiormente dalle cerniere 94° - 95°  
 The weight of the doors must be supported mostly by the 94° - 95° hinges  
 Le poids des portes doit être soutenu en grande partie par les charnières 94° - 95°  
 Das Gewicht der Türen lastet zum Großteil auf den Scharnieren 94° - 95°  
 La mayor parte del peso de las puertas tiene que ser sostenido por las bisagras 94° - 95°

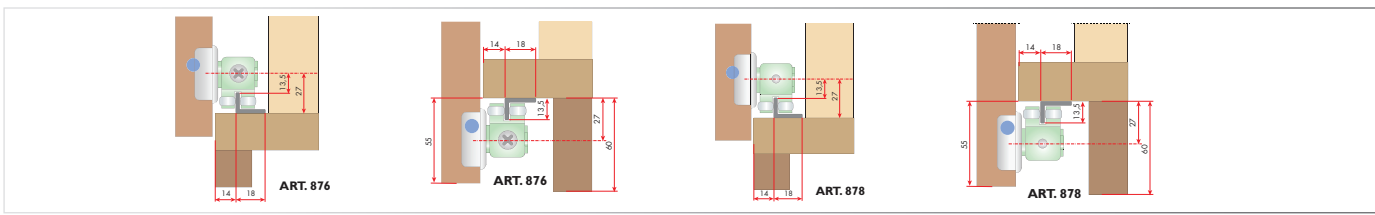

**ART. 1080**  
 Binario in alluminio  
 Aluminium track  
 Profilé en aluminium  
 Aluminiumschiene  
 Guia de aluminio

**ART. 876**  
 Scorrevole con una cerniera  
 One-hinge slider  
 Coulissant à une charnière  
 Schieber mit eine Scharnier  
 Elem. de desliz. con una bisagra

**ART. 870**  
 Binario in alluminio  
 Aluminium track  
 Profilé en aluminium  
 Aluminiumschiene  
 Guia de aluminio

**ART. 869**  
 Scorrevole regolabile con 6 cuscinetti  
 Adjustable slide with 6 bearings  
 Coulisse réglable avec 6 coussinets.  
 Regulierbarer Schliessen mit 6 Lagern  
 Elem. de deslizam. ajustable con 6 cojinetes

**ART. 873**  
 Scorrevole con quattro cerniere  
 Four-hinge slider  
 Coulissant à quatre charnières  
 Schieber mit vier scharnier  
 Elemento de deslizamiento con cuatro bisagras

**ART. 879**  
 Cerniera  
 Hinge  
 Charnière  
 Scharnier  
 Bisagra

**ART. 878**  
 Scorrevole con due cerniere  
 Double-hinge slider  
 Coulissant à double charnière  
 Schieber mit Doppelscharnier  
 Elem. de desliz. con dos bisagras

**ART. 874**  
 Giunzione con due cerniere senza molla  
 Joint with two hinges without spring  
 Assemblage par deux charnières sans ressort  
 Verbindung mit zwei Scharnieren ohne Feder  
 Junta con dos bisagras sin muelle

**ART. 894**  
 Profilo biestruo parapolvere  
 Biextended anti-dust profile  
 Profilé bi-étrudé pare-poussière  
 Doppelgeprägtes staubabweisendes Profil  
 Perfil biextruido salvapolvo

# Sistema per ante a libro multiple incernierate

System for multiple hinged folding doors  
 Systeme pour plusieurs portes pliantes articulées  
 System für mehrtürige falttür mit scharnier  
 Sistema para puerta de librillo individual con bisagra

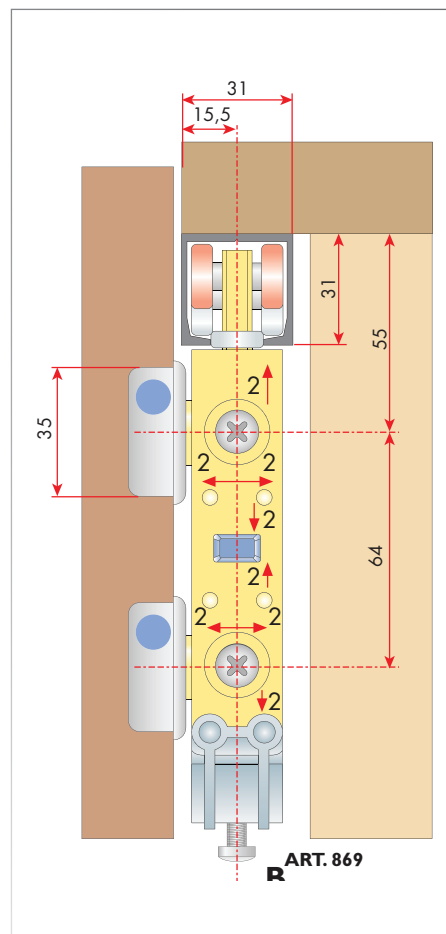
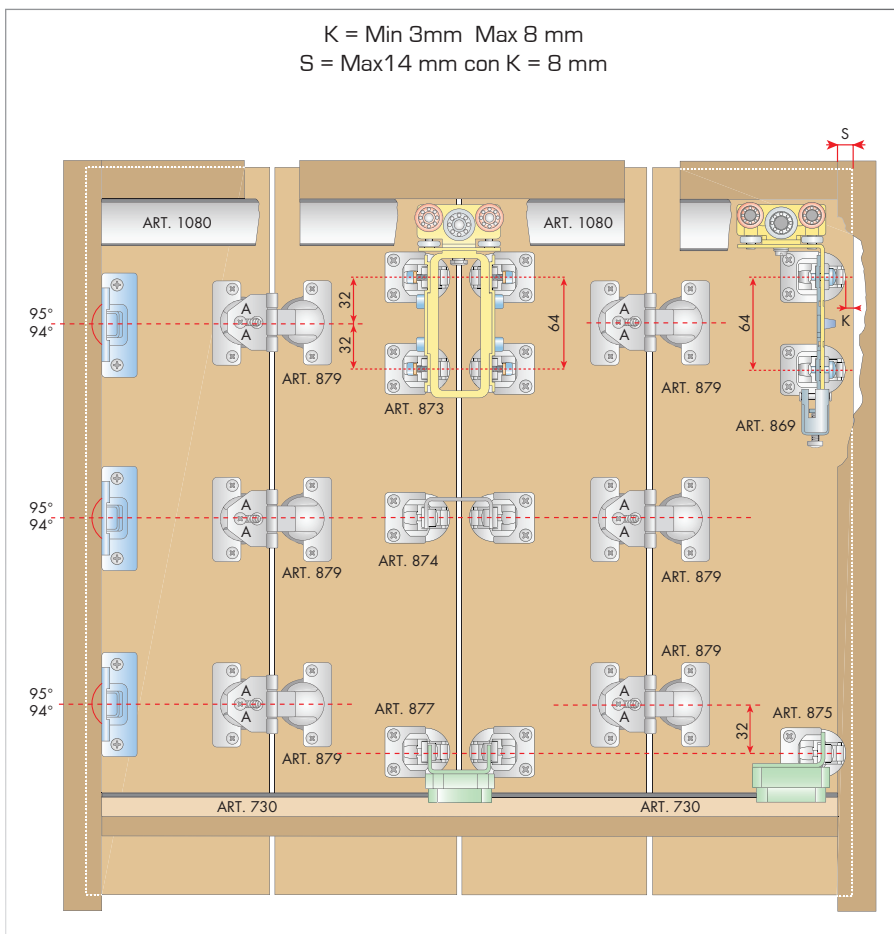

Il peso delle ante deve essere sostenuto maggiormente dalle cerniere 94° - 95°  
 The weight of the doors must be supported mostly by the 94° - 95° hinges  
 Le poids des portes doit être soutenu en grande partie par les charnières 94° - 95°  
 Das Gewicht der Türen lastet zum Großteil auf den Scharnieren 94° - 95°  
 La mayor parte del peso de las puertas tiene que ser sostenido por las bisagras 94° - 95°

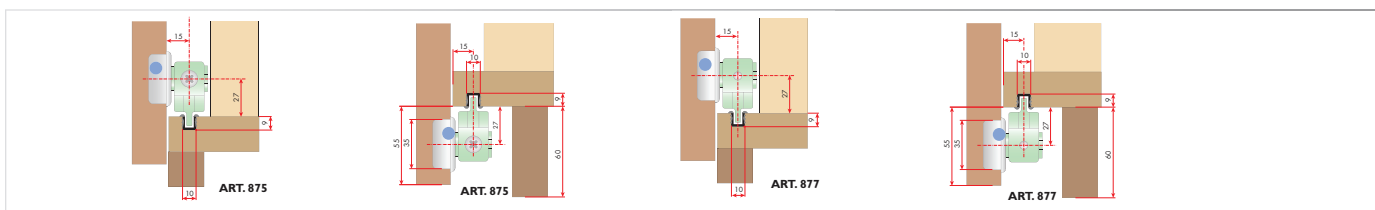

**ART. 1080**  
 Binario in alluminio  
 Aluminium track  
 Profilé en aluminium  
 Aluminiumschiene  
 Guia de aluminio

**ART. 875**  
 Scivolante con una cerniera  
 One-hinge slider  
 Couissant à une charnière  
 Schieber mit eine Scharnier  
 Elem. de desliz. con una bisagra

**ART. 730**  
 Binario in plastica  
 Plastic track  
 Rail en plastique  
 Plastikprofil  
 Carril de plastico

**ART. 869**  
 Scorrevole regolabile con 6 cuscinetti  
 Adjustable slide with 6 bearings  
 Coulisse réglable avec 6 coussinets.  
 Regulierbarer Schlitten mit 6 Lagern  
 Elem. de deslizam. ajustable con 6 cojinetes

**ART. 873**  
 Scorrevole con quattro cerniere  
 Four-hinge slider  
 Couissant à quatre charnières  
 Schieber mit vier scharnier  
 Elemento de deslizamiento con cuatro bisagras

**ART. 879**  
 Cerniera  
 Hinge  
 Charnière  
 Scharnier  
 Bisagra

**ART. 877**  
 Scivolante con due cerniere  
 One-hinge slider  
 Couissant à une charnière  
 Schieber mit eine Scharnier  
 Elem. de desliz. con una bisagra

**ART. 874**  
 Giunzione con due cerniere senza molla  
 Joint with two hinges without spring  
 Assemblage par deux charnières sans ressort  
 Verbindung mit zwei Scharnieren ohne Feder  
 Junta con dos bisagras sin muelle

**ART. 894**  
 Profilo biestruo paraspolvere  
 Biextended anti-dust profile  
 Profilé bi-extrudé pare-poussière  
 Doppelgeprägtes staubabweisendes Profil  
 Perfil biextruido salvapovo

ANTE A LIBRO PER ARMADI

# Sistema per ante a libro multiple libere

System for multiple folding doors  
 Systeme pour plusieurs portes pliantes libres  
 System für mehrtürige falttür ohne scharnier  
 Sistema para puerta de librillo multiples libres



K = Min 3mm Max 8 mm  
 S = Max 14 mm con K = 8 mm

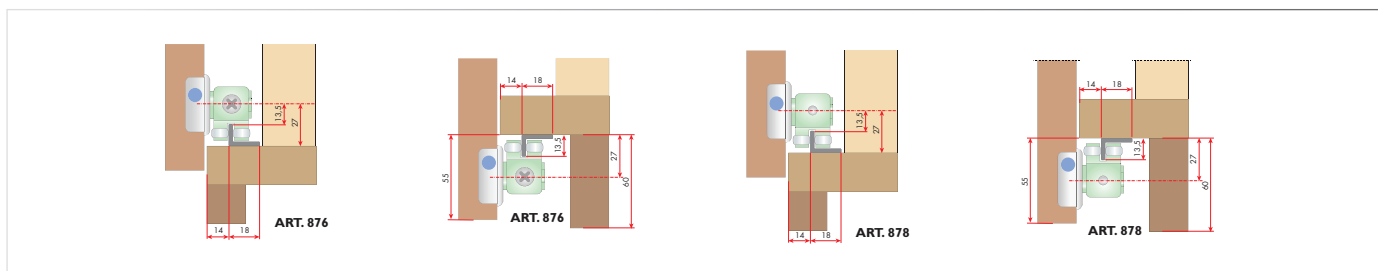
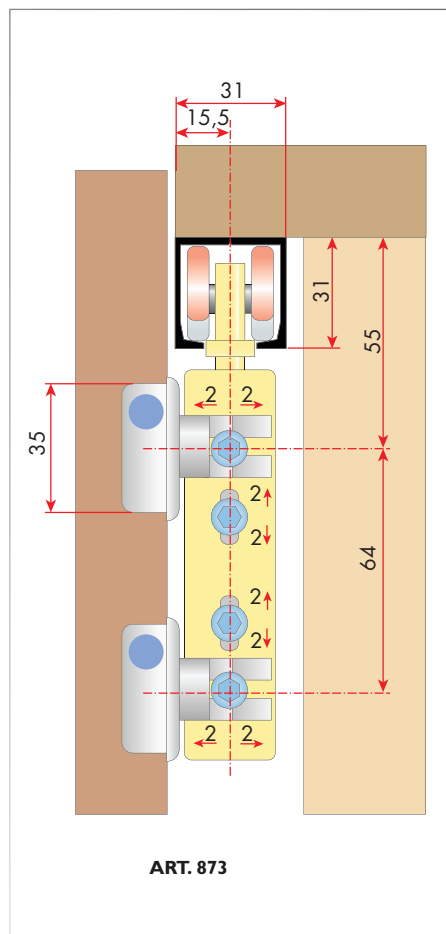
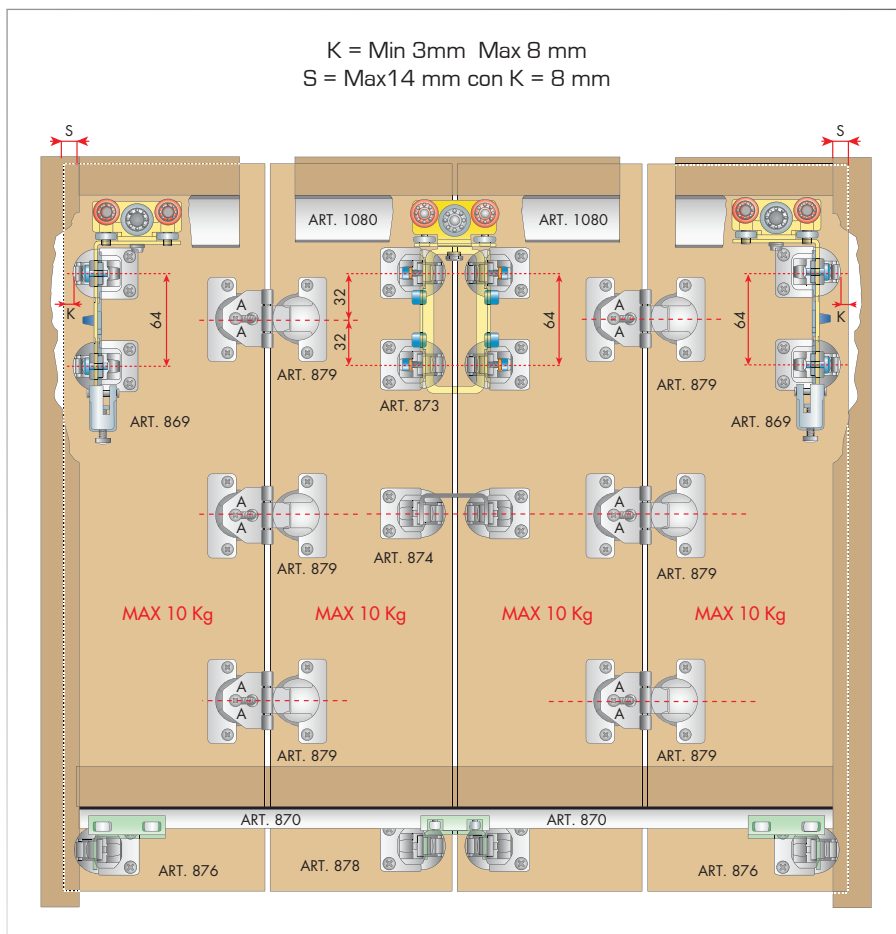

**ART. 1080**  
 Binario in alluminio  
 Aluminium track  
 Profilé en aluminium  
 Aluminiumschiene  
 Guia de aluminio

**ART. 876**  
 Scorrevole con una cerniera  
 One-hinge slider  
 Coulissant à une charnière  
 Schieber mit eine Scharnier  
 Elem. de desliz. con una bisagra

**ART. 870**  
 Binario in alluminio  
 Aluminium track  
 Profilé en aluminium  
 Aluminiumschiene  
 Guia de aluminio

**ART. 869**  
 Scorrevole regolabile con 6 cuscinetti  
 Adjustable slide with 6 bearings  
 Coulisse réglable avec 6 coussinets.  
 Regulierbarer Schlieten mit 6 Lagern  
 Elem. de deslizam. ajustable con 6 cojinetes

**ART. 873**  
 Scorrevole con quattro cerniere  
 Four-hinge slider  
 Coulissant à quatre charnières  
 Schieber mit vier scharnier  
 Elemento de deslizamiento con cuatro bisagras

**ART. 894**  
 Profilo biestruso parapolvere  
 Biextruded anti-dust profile  
 Profilé bi-extrudé pare-poussière  
 Doppelgeprägtes staubabweisendes Profil  
 Perfil biextruido salvapolvo

**ART. 878**  
 Scorrevole con due cerniere  
 Double-hinge slider  
 Coulissant à double charnière  
 Schieber mit Doppelscharnier  
 Elem. de desliz. con dos bisagras

**ART. 874**  
 Giunzione con due cerniere senza molla  
 Joint with two hinges without spring  
 Assemblage par deux charnières sans ressort  
 Verbindung mit zwei Scharnieren ohne Feder  
 Junta con dos bisagras sin muelle

ANTE A LIBRO PER ARMADI

K = Min 3mm Max 8 mm  
 S = Max 14 mm con K = 8 mm

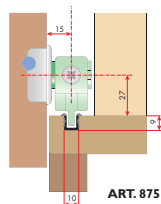
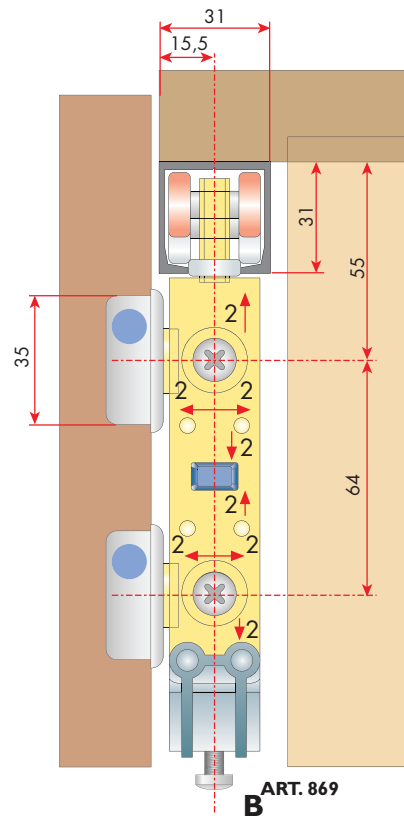
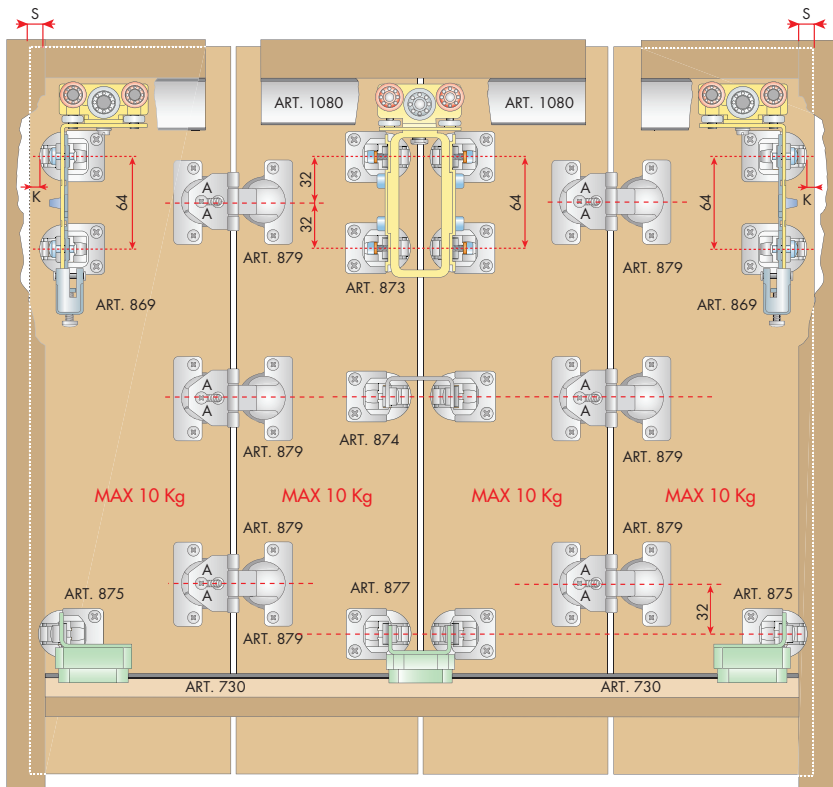

ART. 875

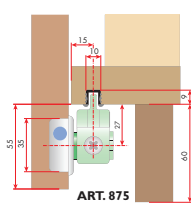

ART. 875

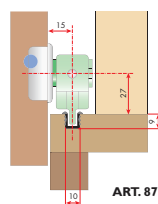

ART. 877

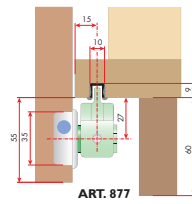

ART. 877



**ART. 1080**  
 Binario in alluminio  
 Aluminium track  
 Profilé en aluminium  
 Aluminiumschiene  
 Guia de aluminio



**ART. 730**  
 Binario in plastica  
 Plastic track  
 Rail en plastique  
 Plastikprofil  
 Carril de plastico

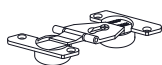

**ART. 879**  
 Cerniera  
 Hinge  
 Charnière  
 Scharnier  
 Bisagra

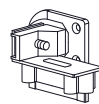

**ART. 875**  
 Scivolante con una cerniera  
 One-hinge slider  
 Coulissant à une charnière  
 Schieber mit eine Scharnier  
 Elem. de desliz. con una bisagra

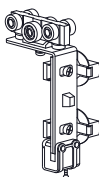

**ART. 869**  
 Scorrevole regolabile con 6 cuscinetti  
 Adjustable slide with 6 bearings  
 Coulisse réglable avec 6 coussinets.  
 Regulierbarer Schlitzen mit 6 Lagern  
 Elem. de deslizam. ajustable con 6 cojinetes

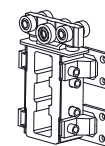

**ART. 873**  
 Scorrevole con quattro cerniere  
 Four-hinge slider  
 Coulissant à quatre charnières  
 Schieber mit vier scharnier  
 Elemento de deslizamiento con cuatro bisagras



**ART. 894**  
 Profilo biestruo parapolvere  
 Biextended anti-dust profile  
 Profilé bi-étrudé pare-poussière  
 Doppelgeprägtes staubabweisendes Profil  
 Perfil bixtruido salvapolvero

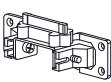

**ART. 874**  
 Scivolante con due cerniere  
 One-hinge slider  
 Coulissant à une charnière  
 Schieber mit eine Scharnier  
 Elem. de desliz. con una bisagra

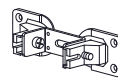

**ART. 874**  
 Giunzione con due cerniere senza molla  
 Joint with two hinges without spring  
 Assemblage par deux charnières sans ressort  
 Verbindung mit zwei Scharnieren ohne Feder  
 Junta con dos bisagras sin muelle



Sistemi per ante a libro di armadi a muro.

Systems for book type panels on built-in closets.

Systèmes pour portes battantes d'armoires encastrables.

Faltbare Türsysteme für Wandschränke.

Sistemas para puertas plegables de armarios empotrados.

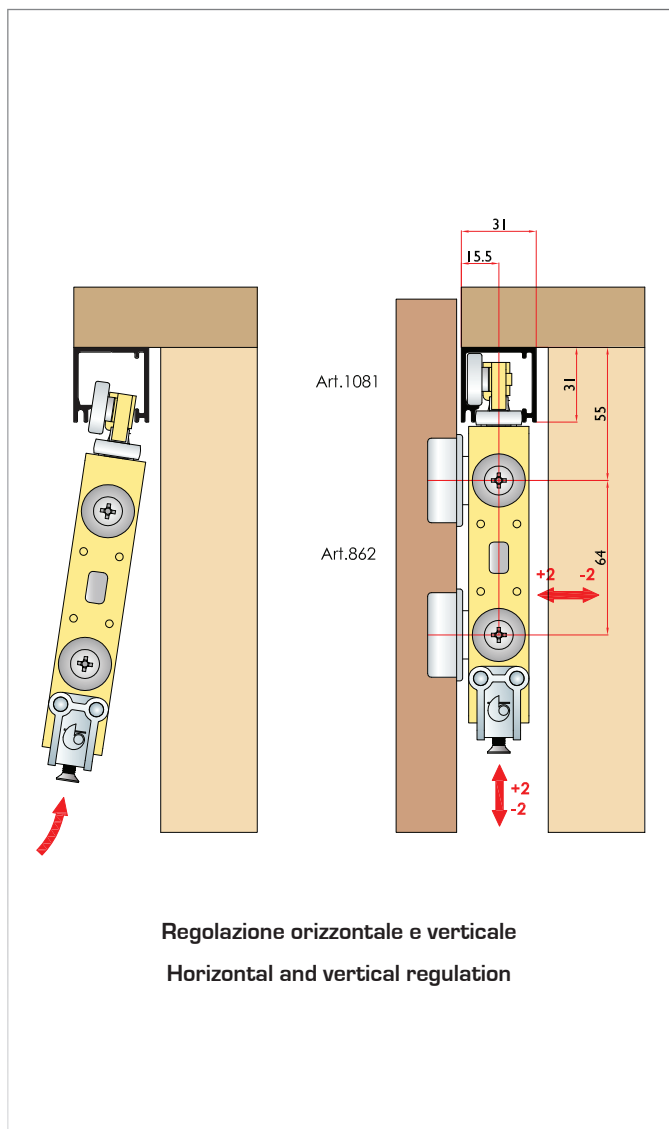
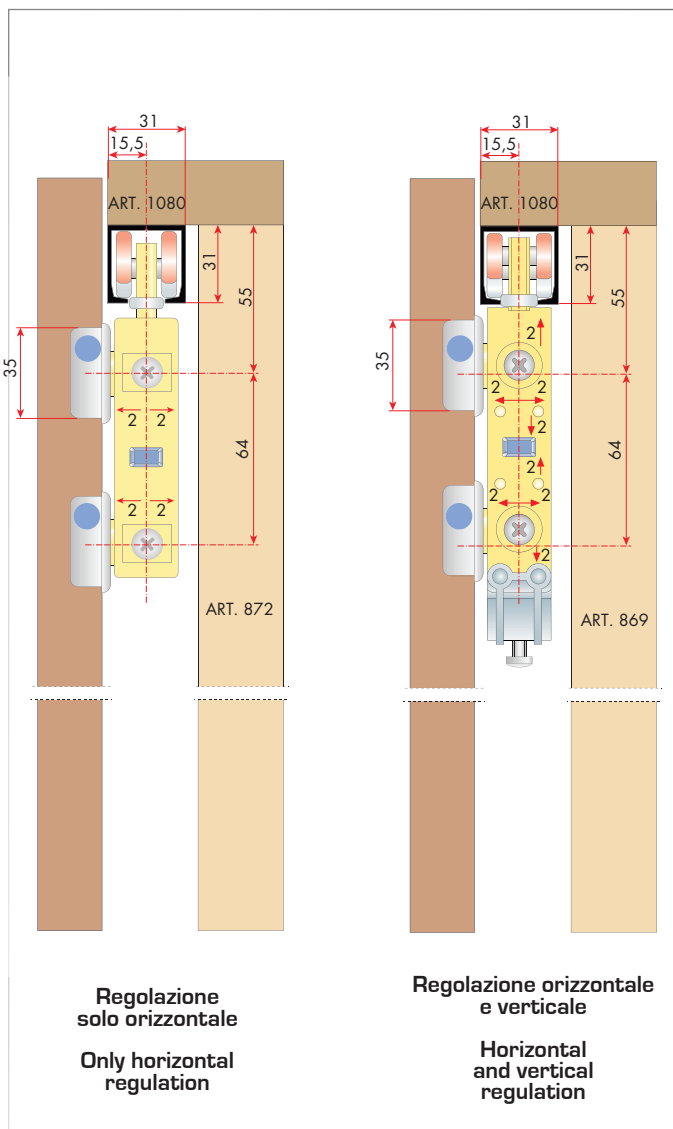

Il peso delle ante "X" e "Y" deve essere sostenuto maggiormente dalle cerniere 110°  
 The weight of the "X" and "Y" doors must be supported mostly by the 110° hinges  
 Le poids des portes "X" et "Y" doit être soutenu en grande partie par les charnières 110°  
 Das Gewicht der Türen "X" und "Y" lastet zum Großteil auf den Scharnieren 110°  
 La mayor parte del peso de las puertas "X" e "Y" tiene que ser sostenido por las bisagras 110°

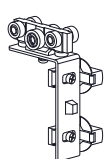

**ART. 872**  
 Scorrevole con 6 cuscinetti  
 Slide with 6 bearings  
 Coulisse avec 6 coussinets.  
 Schlitten mit 6 Lagern  
 Elem. de deslizam. con 6 cojinetes

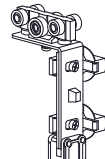

**ART. 869**  
 Scorrevole regolabile con 6 cuscinetti  
 Adjustable slide with 6 bearings  
 Coulisse réglable avec 6 coussinets.  
 Regulierbarer Schlitten mit 6 Lagern  
 Elem. de deslizam. ajustable con 6 cojinetes

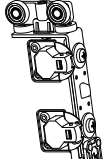

**ART. 862**  
 Scorrevole regolabile con 6 cuscinetti  
 Adjustable slide with 6 bearings  
 Coulisse réglable avec 6 coussinets.  
 Regulierbarer Schlitten mit 6 Lagern  
 Elem. de deslizam. ajustable con 6 cojinetes



**ART. 879**  
 Cerniera  
 Hinge  
 Charnière  
 Scharnier  
 Bisagra



**ART. 1080**  
 Binario in alluminio  
 Aluminium track  
 Profilé en aluminium  
 Aluminiumschiene  
 Guía de aluminio



**ART. 1081**  
 Binario in alluminio  
 Aluminium track  
 Profilé en aluminium  
 Aluminiumschiene  
 Guía de aluminio